

A NEW CONCORDANCE
OF THE PYRAMID TEXTS

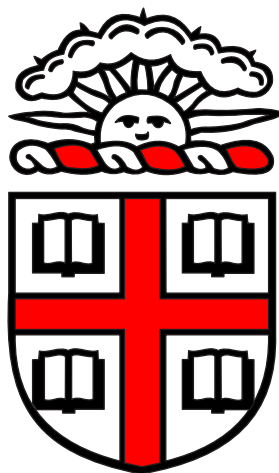



























JAMES P. ALLEN

VOL. III
PT 247-421









BROWN UNIVERSITY
2013

PT 247

	W'	W		W'	W		W		W		W		W				
1 257a		A/Wg 1		4 258b			6 258d			9 259b			12 260a-b			14 261a	
2 257b-c							A/Wg 6			10 259b			A/Wg 9			15 261a-b	
		A/Wg 2		5 258c			A/Wg 8			11 260a			A/Wg 7			A/Wg 11	
					A/Wg 5		7 259a			13 260c			A/Wg 10				
3* 258a				3 erased at end			A/Wg 7										

PT 248

	W'	W		W		W
		(A/Wg 11)				
1 262a			3 263a		4 263b	
		A/Wg 12		A/Wg 13		
2 262b						→

PT 249

	W'	W	W	W'	W
<p>1 264a</p>		<p style="text-align: center;">A/Wg 14</p> 	<p>4 265a</p>		
<p>2*</p> <p>264b-c</p>		<p>5 265b</p>	<p>7 265d</p>	<p>9 266a</p>	
<p>3</p> <p>264c</p>		<p>6 265c</p> <p style="text-align: center;">A/Wg 16</p> 	<p>8 265e</p> <p style="text-align: center;">A/Wg 17</p> 	<p>10 266b</p>	<p style="text-align: center;">A/Wg 18</p> 
		<p>2</p> <p>△ erased</p>			<p style="text-align: center;">→</p>

PT 250

	W'	W		W		W'	W
1 267a		(A/Wg 18)		A/Wg 19		7 268b	
			3 267c				
			4 267c				
2 267b					8 268c		
			5* 267d				A/Wg 21
5	~~~~~ erased after first					9 268d	
				A/Wg 20			
			6 268a				→

PT 251

	W		W		W		W
	(A/Wg 21)				A/Wg 25		
1 269a		3* 270a		6 270d		8 271a	
			A/Wg 23		A/Wg 24		
	A/Wg 22					9 271b	
2 269b		4 270a-b		7 270e			
		5 270c					→
				3 erased after			

PT 252

	W'	W
1 272a		A/Wg 26
2 272b		
		A/Wg 27

5
first 
added in paint







	W
3 272c- 273a	
4 273a	A/Wg 28



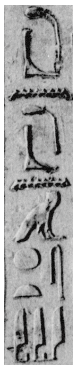

	W'	W
5* 273b		
6 273c		
		A/Wg 29
		A/Wg 30





	W'	W
7 274a		
		A/Wg 31





	W
8 274b	
9 274c	A/Wg 32

	W	T
1 275a	A/Wg 33 	(A/W 27) 
2 275b	 A/Wg 34 	

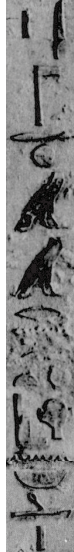

	W	T
3 275c	 A/Wg 35 	
4 275d	 A/Wg 36 	

	W	T
5 275e		A/W 28 
6 275f	 A/Wg 37	 → PT 364



	W	T
1 276a	A/W 1 	A/W 1 
2 276b		

	W	T
3 276c		
4 277a		

	W	T
5 277b		
6 277c	A/W 2 	





	W	T
7 278a		
8 278b		

	W	T
9 278c		
10 279a		

W	T
	
	... 
	AW 3
	

11
279b





12
279c

W	T
	
	
	
	AW 4
	

13
279d

14
279d

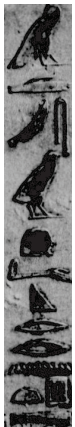

15
280a

W	T
	
	
	
	AW 4
	
	AW 5
	

16
280b



17
280c

18
281a

W	T
	
	
	

19
281b

20
282a

W	T
	
	

21
282b-c

	W	T
22 282c	A/W 6 	A/W 5
23 283a		
24 283b		





	W	T
25 284a		
26 284b	A/W 7 	

	W	T
27 284c- 285a		
28 285a-b		A/W 6

	W	T
29 285c		
30 285d	A/W 8 	
31 286a		

	W	T
32 286b-c		
33 286c		
34 286d		A/W 7

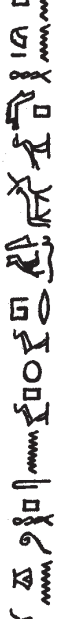
35
286e

W	T
	
	
	

A/W 9

36
287a-b



37
287c

W	T
	
	





A/W 10

38
288a



A/W 8

39
288b



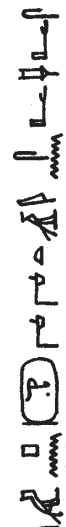
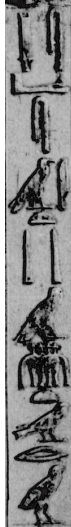

W	T
	
	

A/W 11

40
288c





41
289a

W	T
	
	

A/W 12

A/W 9

43
289c

W	T
	

44
290a

W'	W	T
	A/W 13	

45
290b

46
290c

47
290d-
291a

W	T
A/W 14	
	A/W 10

48
291a-b

49
291b

50
291c

W	T
A/W 15	

51
291d

52
292a





53*
292b

W	Sethe	T
	A/W 16	

54
292c



53 T both instances of
altered
from

55
292d

W	Sethe	T
		A/W 11 
		





56
293a

57
293b

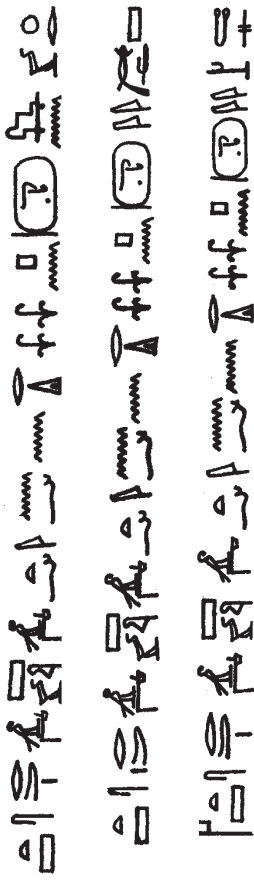

W	T
	
	

58
293c

59
294a-c

W	Sethe	T
		A/W 12 
		
		
		



1
295a

W	Sethe	T
(A/W 18) 		(A/W 12) 
		
		
		
		
A/W 19 		

2
295b

3
295c



4
295d

W	T
	
	
	A/W 13 
A/W 20 	

5
296a



6
296b

7
297a

W	T
	
	

































8
297b

9
297c-d

W	T
A/W 21 	

(PT 255)













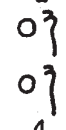

10
298a

W	T
	
	
	
	
	
	
	
	
	
	
	
	
	
	
	
	

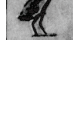
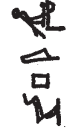
A/W 22

























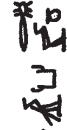

A/W 14

11
298bc

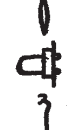
W	T
	
	
	
	
	
	
	
	
	
	
	
	
	
	

12
299a

13
299b

W	T
	
	
	
	
	
	
	
	
	
	
	
	
	
	

A/W
23











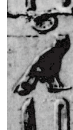

14
200a

15
300b

W	T
	
	
	
	
	
	
	
	
	
	
	
	
	
	

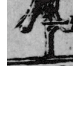
A/W 24

16
300c

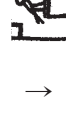
W	T
	
	
	
	
	
	
	

	W	T
1 301a	(A/W 24) 	A/W 15
2 301b	A/W 25 	

	W	T
3 301c		
4 302a-b	A/W 26 	

	W	T
5 302c-d		
6 303a		

	W	T
7 303b		
8 303c		
9 303d	A/W 28 	









	W	T
1 304a	(A/W 28) 	A/W 17
2 304b		
3 304c		
4 304d	A/W 29 	





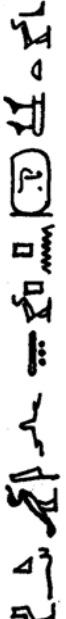

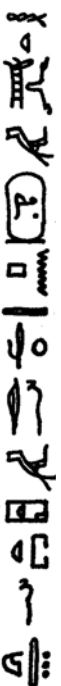
	W	T
5 304e		
6 305a		
7 305a		A/W 18
8 305b	A/W 30 	

	W	T
9 306a		
10 306b-c		

	W	T
11 306d	A/W 31 	
12 306e		
13 307a		

	W	T
14 307b		
15 307c	A/W 32 	

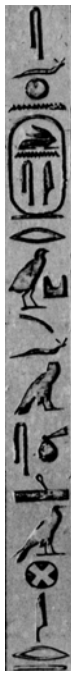
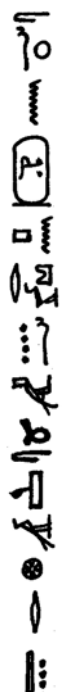
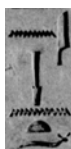
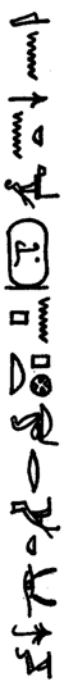

	W	T ^a	T ^b
1 308a 312a	(A/W 32) 	A/W 20 	(A/W 23) 
2 308b 312b			
3 308c 312c			

	W	T ^a	T ^b
4 308d			
		A/W 33	
5 308e 312e			
		A/W 21	

	W	T ^a	T ^b
6 308f 312f			
7 309a 313a			
		A/W 34	







*1 Sethe's PT 258 is W and T^a, PT 259 is T^b

8
313b

W	Ta	Tb
		

9
309b
313c

10
309c
313d

W	Ta	Tb
		
		

11
309d
313f





12
309e
313e

A/W 35

A/W 22

A/W 25

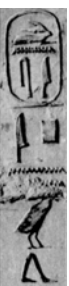
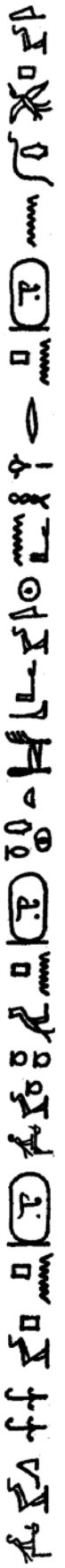
13
310a
314a

W	Ta	Tb
		
		



14
310b
314b

15
310c
314c

A/W 26

*1 12 precedes

16
310d
314d

W	Ta	Tb
		

17
310e
314e



18
311a
315b





A/W 36



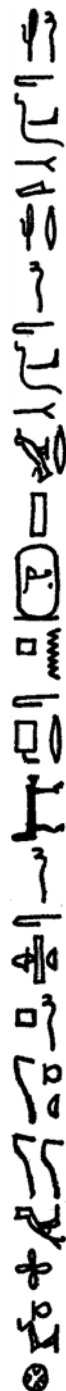

A/W 23

19
311b
315a

W	Ta	Tb
		

20
311c
315c

21
311d
315d

W	Ta	Tb
		
→ PT 260	→ PT 259	→ PT 253

*1 19 precedes

PT 260

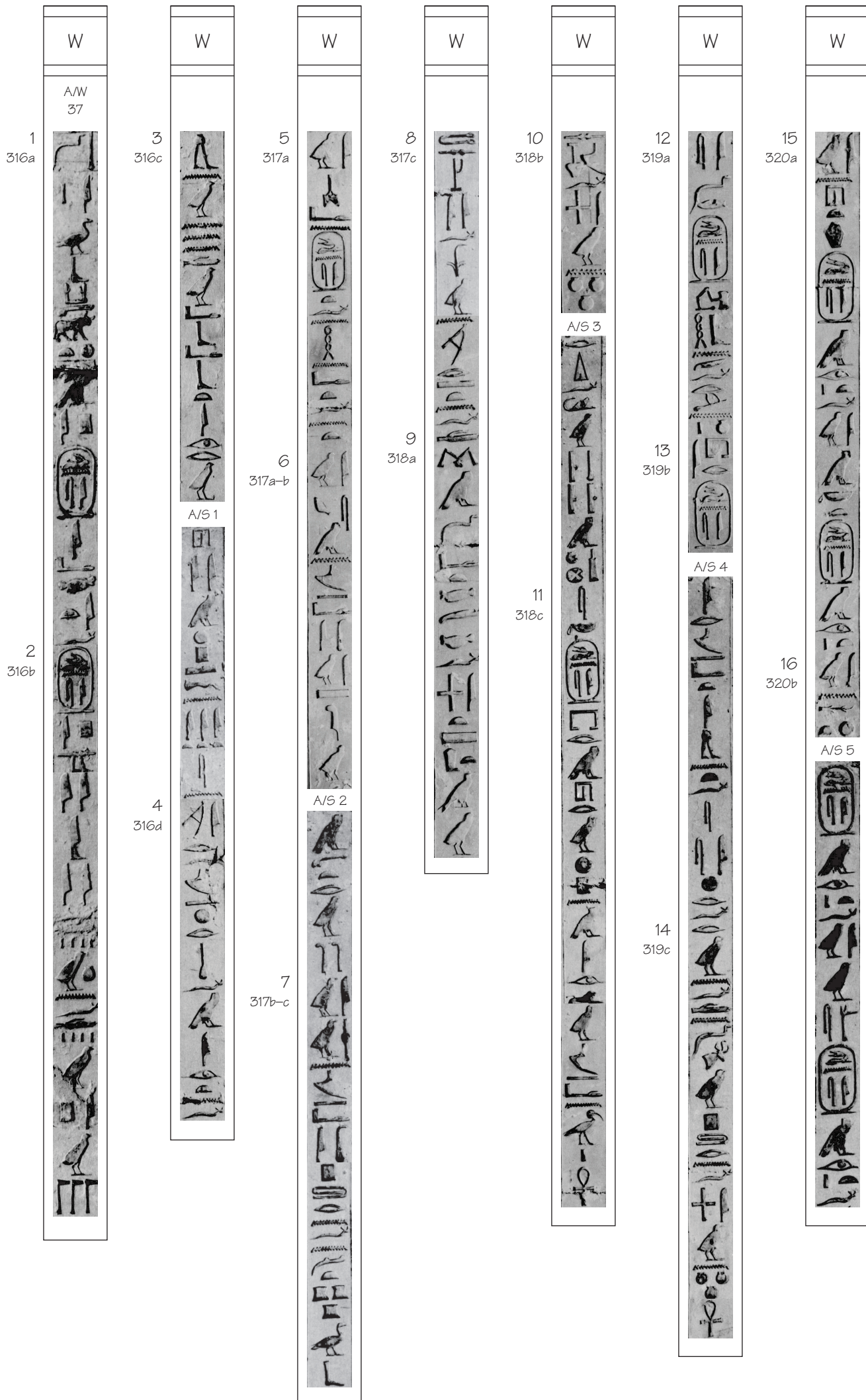

(PT 260)



25
Dividing line
added in paint







	W	P
1 324a	(A/S 8)	(A/N 32)
2 324b		
3 324c		
	A/S 9	

	W	P
4 324d		
5 325a-b		







	W	P
6 325b-26a		
	A/S 10	

	W	P
7 326b		
8 326c		
9 326d		
		→ PT *754

1
327a

W	T	P	N	Wd
(A/S 10)	P/S 1	(A/S 23)	(B/Sw ii 26)	(B/Nw 9)
				
A/S 11		A/S 24		... (lost to 4)
				

2
327b

W	T	P	N
			
			B/Sw ii 27
			...
	P/S 2		
		(lost to 1st)	
			

3
327c

			
---	--	--	--

4
328a

W	T	N	Wd
			(B/Nw 10)
A/S 12			
5 328b			
	P/S 3		
			B/Sw ii 28
			(rest lost)







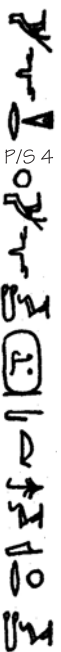

6
328c

W	T	P	N

7
329a

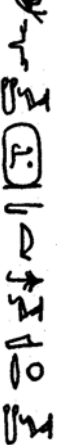
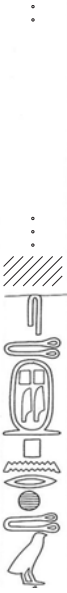

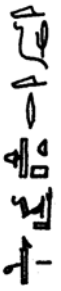
W	T	P	N
	A/S 25		

8
329b







W	T	P	N
			
A/S 13	P/S 4	...	B/Sw ii 29
			
			
		(lost to 12)	

9
329c

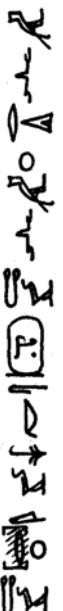
10
330a

W	T	N
		
	P/S 5	

11
330b

W	T	P	N
			
		B/Sw ii 30	
			
A/S 14			

12
330c

13
331a

W	T	P	N

14
331b

W	T	P	N

15
331c

--	--	--	--

16
332a

W	T	P	N

17
332b

W	T	N
	P/S 8	B/Sw ii 32

18
332c

--	--	--

19
333a

W	T	P	N
A/S 16			B/Sw ii 33

20
333b

--	--	--	--

21
333c

W	T	P	N
	P/S 9	A/S 27	

22
334a

W	T	P	N

23
334b

A/S 17
P/S 10

...
... (lost to 26)

B/Sw ii 34

24
334c

W	T	N

25
335a

W	T	N

P/S 11
B/Sw ii 35

26
335b

W	T	P	N
A/S 18	P/S 12	A/S 28	
		B/Sw ii 36	

27
335c

28
336a

W	T	P	N
	P/S 13	(rest lost) PT *706	

29
336b

W	T	N
	A/S 19	B/Sw ii 37
→	→ PT 264	→ PT 458

1
342a

T	P
P/S 14	(B/E 24)
P/S 15	B/E 25

2
342b

3
342c

T	P
P/S 16	

4
342d

5
343a

T	P
P/S 17	
	B/E 26

6
343b

7
344a

T	P
P/S 18	
	B/E 26

8
344b

9
344b

10
345a

T	P
P/S 19	
	B/E 26

11
345b

	T	P
12 346a		B/E 27
13 346a-b		

	T	P
14 346c		
15 347a		

	T	P
16 347b		
17 348a		

	T	P
18 348a-b		
19 348c		
20 348c		

	T	P
21 349a		
22 349b		

(PT 264)

T	P
23 350a	
24 350a	

T	P
25 350b	

T	P
26 350c	

→
PT
272

→
PT
595

P

(A/W 11)

1 351a

2 351b

3 351c

A/W 12

P

4 351d

5 352a

6 352b

P

7 353a

8 353b

9 353c

10 354a

P

11 354b

12 355a

A/W 13

13 355b-c

P

14 355c

15 356a

16 356b

P

17 356c

18 356d

19 357a

P

20 357b

21 357c

22 357d

→ PT 470

	P	Wd		P	Wd		P	Wd		P	Sethe	Wd
1 358a-b	(Cn/W 93)			5 359a	 Cn/W 96		8 360b	(B/E B 4)		10 361a	 Cn/W 98	(B/E B 5)
2 358c-d	Cn/W 94		3 358e-f	6 359b			9 360c-d			11 361b		
				7 360a						12 361c		
		(B/E B 3)										
												
												
												
												
												
												
												
												
												
												
												
												
												
												
												

in final lacuna

	P	Sethe	Wd
	Cn/W 99		(B/E B 6)
13* 362a			
14 362b			

13 P
At top read

16
At top left read

	P	Sethe
15 363a		
16 363b		
17 363c		

	P	Sethe
18 363d		
19 363e		
20 363f		

→
PT
533

	W	T	P	M	N
	(A/S 24)	(A/S 6)	(A/S 5)	B/Sw i1	(B/S e B 87)
1 364a					
2 364b					
		(S of 1st)			

	W	P	M	N
3 365a				
4 365b				
				(B/S e B 88)

	W'	W	T	P	M	N
5 366a						
6 366b						

	W'	W	T	P	M	N
7 366c						
8 367a						
9 367b						
10 367b						

(B/Sw
i 2)

B/Se B 89

... (rest lost) ↑
309

... (lost to 14)

	W	P	N
11 368a		—	—
12 368b			
13 368b-c			

	W	T	P	N
14 369				
	→	→ PT 271	→ PT *737	→ PT 309

1
370a

W	T	P	An	N	Nt
(A/S 27)	A/S 4	(B/Sw A 22)	B/E ii 32	(B/Nw ii 5)	B/Nw 32
	(rest of line)		B/E ii 33	B/Nw ii 6	
			B/E ii 34		

2
370b

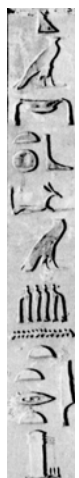

3
371a

W	P	An	N	Nt
A/S 28	B/Sw A 23			
			B/E ii 35	
	(rest of line)			
	PT 412		B/E ii 36	
				B/Nw 33
				B/Nw ii 7

4
371b

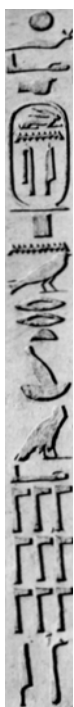

	W	T	An	N	Nt
5* 371c					
			B/E ii 37		
6* 372a					
			B/Nw ii 8		
7 372b					
	A/S 29				

	W'	W	T	An	N	Nt
8 372c						
			A/S 5			B/Nw 34
9 372d-e						
			(21 to 12)	B/E ii 38		B/Nw ii 9

5-6 W erased after each verb

10
372e-
373a

W'	W	An	N	Nt
	 A/S 30	 ...		 B/Nw 35

11
373b

12
373c

W	T	An	N	Nt
			 B/Nw ii 10	

13
374a

B/E ii 39

	W'	W	T	An	N	Nt
14 374b						
	A/S 31 	A/S 6 				
15 374c						

	W'	W	T	An	N	Nt
16 375a						
17 375b						

→
PT 363
→
PT 267
→
PT 625A
→
PT 476

	W	P	Sethe	M	Wd
1 376a	A/S 32	(VW 9)		C/Nw 1	B/Nw x
2 376b				//// (lost to 5)	//// (lost to 6)
3 376c					

	W'	W	P	Sethe	M
4 377a					(C/Nw 3)
5 377b					

	W'	W	P	Sethe	M	Wd
6 377c						(B/Nw x+1)
7 378a						

	W'	W	P	M	Wd	
8 378b						A/S 34
9 379a						C/Nw 5

10
379b

W	P	M	Wd
			 (B/Nw x+2)
	 V/W 11	 C/Nw 6	 A/S 35

11
379c

12
380a

W'	W	P	Sethe	M	Wd
				 C/Nw 7	 (B/Nw x+3)

13
380b

14
381a-b

W	P	M
		C/Nw 8
A/S 36		

15*
381c

W	P	M	Wd
			(B/Nw x+4)
			C/Nw 9
V/W 12			

16
381d

--	--	--	--

17
382a

W	P	Sethe	M	Wd
				(B/Nw x+5)
				C/Nw 10
A/S 37				
→	→ PT 565	→ PT 565	→ PT 262	→

18
382b

--	--	--	--	--

15 Wd
Final sign probably

1
383a

W	T	P	An	M	N
(A/S 37)	(A/S C x+3)	(A/W 32)	(B/E ii 2)	A/W 46 + fr. Or C	A/W 28
		B/E ii 3			

2
383b









3
383c

W	T	P	An	M	N
	(A/S C x+4)				
	A/S 38				
	4 384a				
	5 384b				
					A/W 29

	W	T	P	An	M	N
6 385a				 B/E ii 4	 A/W 47 + fr. Or C	
7 385b	_____	_____	 A/W 33		_____	_____
8 385c		_____				

	W	T	P	An	M	N
9 386a	 A/S 39	 (A/S C x+5)		 A/W 30		
	_____		 B/E ii 5			
	_____	_____				









1
388a

W'	W	T	P	N
	(A/S 40) 	(A/S 8) 	(VE 16) 	A/W 60 
		A/S 9 	VE 17 	

388b

4 W
 added secondarily

3
388c

W'	W	T	P	N
	A/S 41 			
				
				

4*
389a

5
389b

6
390a

W'	W	T	P	N
				A/W 61
		A/S 10		
	(ol test) ...			

7
390b

8
391a



W'	W	P	N
	A/S 42		

9*
391b







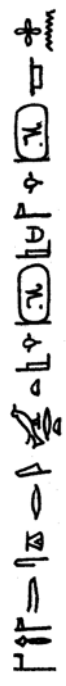





9 W

added *secondarily*

10
391c

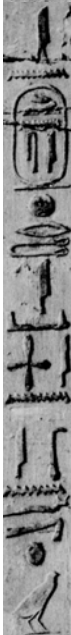





	W	T	P	N
				
→		→ PT *715	→ PT 558	→ PT 471

1
392a

W'	W	T	An	N
	(A/S 42)	(P/S 25)	B/E ii 1	(B/Nw ii 20)
				
	A/S 43			
				
		P/S 26		
				

2*
392b

3
392c

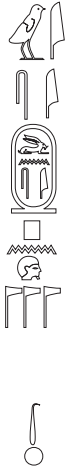
W'	W	T	An	N
				
				B/Nw ii 21
				
			B/E ii 2	
				
	end	end	→ PT 270	→ PT 626

4
392d

2 W
 as det. of j.wn erased

		W	T
1 393a		A/Eg 1 	A/E 28 //... ...
	2 393b	A/Eg 2 	
	3 393c	A/Eg 3 	

		W	T
4 394a		A/Eg 4 	
	5 394b	A/Eg 5 	

		W	T
6 394c		A/Eg 6 	
	7 395a		A/E 29 //...





		W	T
8 395b		A/Eg 7 	
	9 395b		
10 396a		A/Eg 8 	

		W	T
11 396b		A/Eg 9 	
	12 396c		A/E 30
13 396d		A/Eg 10 	



	W	T
14 397a		
	A/Eg 11	
15 397b-c		

	W	T
16 398a		
	A/Eg 12	
17 398b		
		A/E 31
18 398c		

	W'	W	T
19 399a			
		A/Eg 13	sic
20 399b			
			sic
21 399c			

	W	T
22 399d		
		A/E 32
23 400a		
	A/Eg 14	
24 400b		

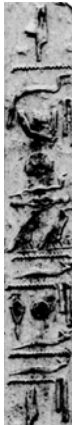
25
401a

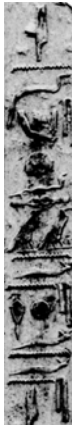
W	T
	
	

26
401b





27
401c

W	T
	
	

28
402a

29
402b



30
402c

W	T
	
	

31
403a



32
403b

33
403c

W	T
	

34*
404a



35
404b

W	T
	

36*
404c

34 W
Dots added in paint

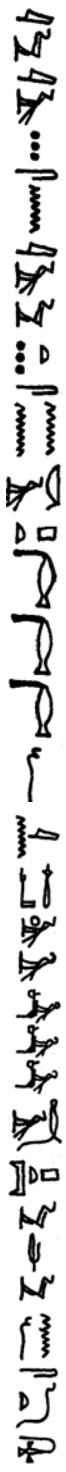

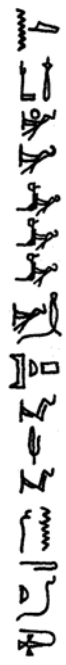
36 W
Dots added secondarily

W	T
A/Eg 18	
	
	

37*
404d

38
405a





37 W
Dots above 
barely visible

W	T
	A/E 35
	
	

39
405b





40
406a

A/Eg 19

W	T
	
	

41
406b





42
406c

W	T
	
	

43
407a

44*
407b





44 W
Dots added
secondarily?

W	T
	
	

45
407b-c

46
407d

A/Eg 21

W	T
	
	



47
408a

48
408b

W	T
	
	

49
408c

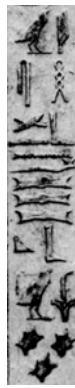
50
409a

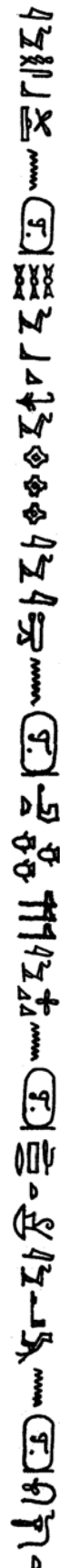
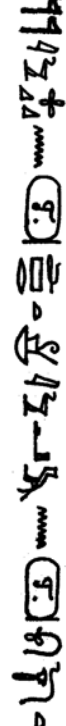
W	T
	
	

51
409b

52
409c

53
410a

W	T
	
	





54
410b



55
410c



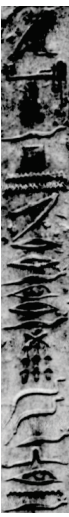

W	T
	
	

56
411a



57
411b

	W	T
58 411c		
59 411d		
60 412a		
	A/Eg 25	
	A/Eg 26	

	W	T
61 412b		
62 412c		
	A/E 40	

	W	T
63 413a		
64 413b		
		
	A/Eg 27	
	A/Eg 28	

	W	T
65 413c		
66 414a		
	A/Eg 29	

	W	T
67 414b-c		
68 414c		
		
	A/Eg 30	
		← PT 400

PT 275

W	
1 415a-b	(A/Eg 30)
	A/Eg 31
2 415b-c	
	A/Eg 32
	A/Eg 34

W	
3 416a	
	A/Eg 33
4 416b	
	A/Eg 34
5 416c	
	→

PT 276

W	
1 417a	A/Eg 35
2 417b	
	A/Eg 36
	→

PT 277

W	T	Nt	
1 418a	A/E 1 	(A/E 8) 	(B/E i 55)
2 418b		A/E 9 	
3* 418c			B/E i 56
	→	→ PT 290	→ PT 284

3 Nt

PT 284 begins near the end of the lacuna at the top of B/E i 57. A  sign at the bottom of B/E i 58 (PT 290) indicates that PT 277 concluded at the top of B/E i 57.

PT 278

PT 279



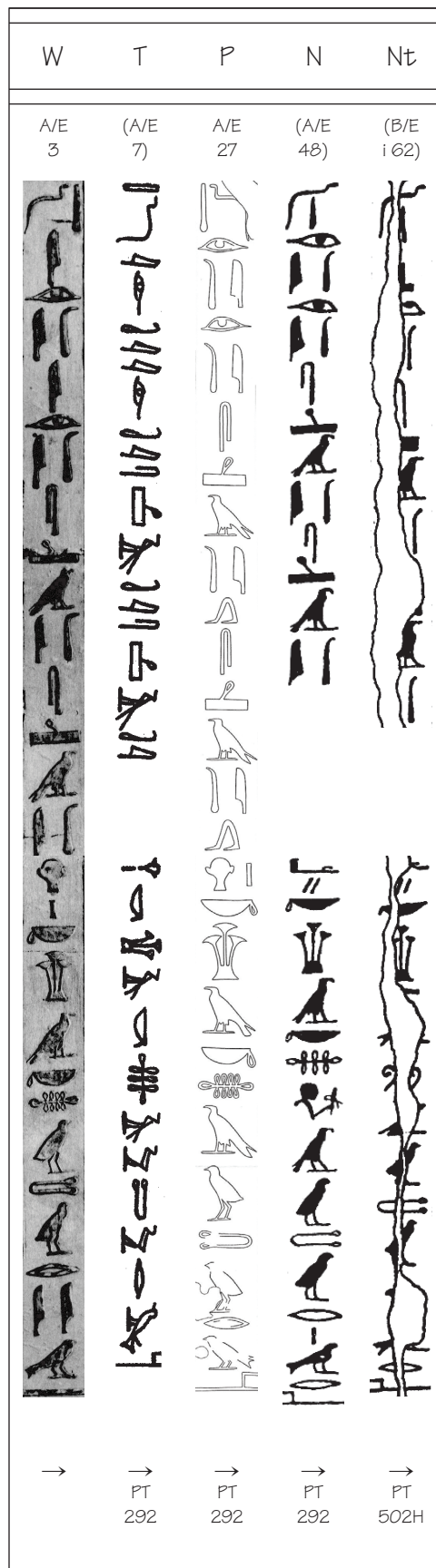
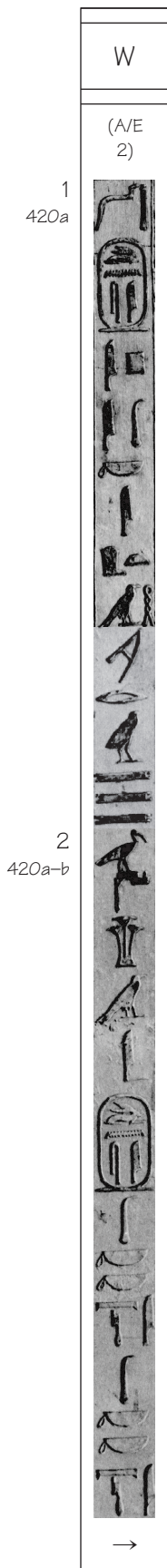
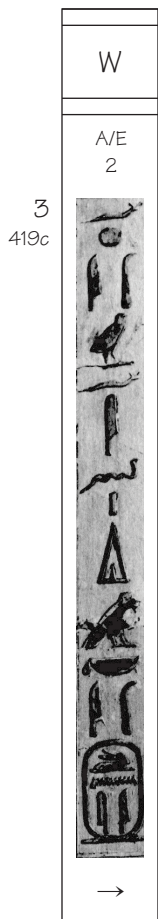











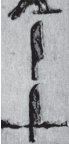







PT 280













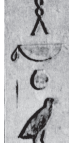



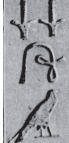













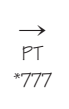
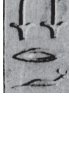

280.3 Nt Read

	W'	W	T	N
1 422a		(A/E 3)	(A/E 2)	(A/E 43)
2 422b			A/E 3	
		A/E 4		

	W'	W	T	N
3 422c				
4 422c				
				A/E 44
5 422d				
				PT 499

	W	T	N
1 423a	(A/E 4) 	(A/E 3) 	(A/E 56) 
2 423b	A/E 5       	      	      

4 W
 hacked out

	W	T	N
3 423b-c	       	       	          
4* 423c	     	A/E 4      	        

→
 → PT
 *77

	W	P	An	N	Nt
	(A/E 6)	(A/E 24)	(B/E ii 47)	(A/E 46)	(B/E i 56)
1 425a					
2 425b					
			→ PT 283	→	→ PT 283

	W	P
3 425c		
	A/E 7	
4 425d		
		A/E 25
5 425e		
	→	→

	W'	W	T	P	An	N	Nt
1 426a		(A/E 7) 	(A/E 4) 	(A/E 25) 	(B/E ii 48) 	(A/E 46) 	(B/E i 57)
2* 426a-b					B/E ii 49 		
3 426b		A/E 8 					
							→ PT 291

	W	T	P	N
4 426c				
5 426d				
6 426d				

2 N First preserved sign ?

→ PT 291

1
427a











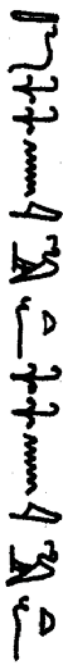
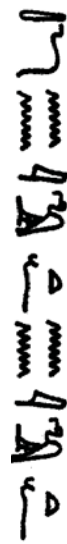





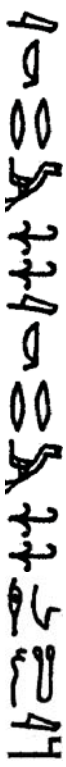

W	T	P	N	Nt
(A/E 8)	(A/E 5)	A/E 26	(A/E 47)	B/E i64
A/E 9 				

2
427b

3
427b-c



W	T	P	N	Nt

4
427a

	W'	W	Ta	Tb	P	N	Nt
1* 428a		(A/E 9) 	(A/E 5) 	(A/E 14) 	(A/E 26) 	(A/E 47) 	(B/E i 64) 
		A/E 10 				A/E 48 	
2* 428b							
3 428b							
		→	→	→ PT 382	→ PT 280	→ PT 280	→ PT *777

1 Nt
For second sign read 

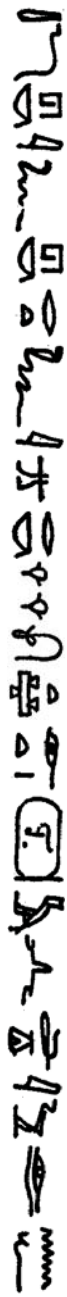
1-2 N
Enough space in lacuna
for two full repetitions

	W	T
1 429a-b	(A/E 10) 	(A/E 6) 
2 429b		

	W	T
3 429c		
	A/E 11 	
4 429c		
	→	→

PT 289

	W	T	An
	(A/E 11)	(A/E 6)	(B/E ii 51)
1 430a			
			...
			...
			B/E ii 52
			...
2 430b			
	→	→ PT 277	→ PT *777

290.1 N
Room in lacuna only for W or Nt version

PT 290

	W	T	N	Nt
	(A/E 11)	(A/E 7)	(A/E 42)	B/E i 59
1* 431a				
	A/E 12			
				...
				→ PT *776
2 431a				
				→ PT *776

	W	T
3 431b		
4 431b		
	→	→

PT 291

PT 292

1
432a

W	T	An	N	Nt
(A/E 12)	(A/E 7)	A/E 50	(A/E 55)	B/E 158
→	→ PT 280	→ PT *776	→ PT 502C	→ PT 290









2
432b

1
433a







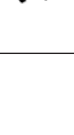



























W	T	P	N
(A/E 13)	(A/E 8)	(A/E 27)	(A/E 48)
→	→	→	→ PT *792

2
433b

1
434a







































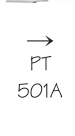











W	T	P'	P
(A/E 13) 	(A/E 8) 	(A/E 27) 	
A/E 14 	 sic		
	 sic		
			
2 434b 	 sic		
3 434c _____	 sic	_____	
	 sic	_____	
		_____	

4
434d

W	T	P'	P
			
			
			
			
			
			
			
			
			
			
			
			

5
434e

6
435a

W	T	P
		
		
		
		
		
		
		
		
		
		
		
		
		
		
		
		
		

7
435b

3
434c

A/E 9

A/E 28

A/E 15

PT 240

PT 501A

1
438a

W	T	An	N	Nt
(A/E 18)	(A/E 12)	(B/E ii 46)	(A/E 42)	(B/E i 54)

2
438b

W	T	An	N	Nt
(A/E 18)	(A/E 12)	(B/E ii 46)	(A/E 42)	(B/E i 54)

3
438c

W	T	An	N	Nt
A/E 19				
→	→	→ PT 284	→ PT 290	→ PT 277



PT 296

	W'	W	T	An	N	Nt
1 439a		(A/E 19)	A/E 13	(B/E ii 44)	(A/E 54)	(B/E i 51)
2 439b						
					A/E 55 ...	
						B/E i 52 ...

	W'	W	T	An	N	Nt
3 439c		A/E 20				
	→	→ PT 379	→ PT 298	→ PT 291	→ PT 298	



PT 297

1
440a-b

W	N
(A/E 20)	(A/E 45)
	

2
440b-c





3
440d

W'	W	N
	A/E 21	
		

4
441a

W	N
	



5
441b

W	N
	
A/E 22	A/E 46
	
→	→ PT 291

	W	An	N	Nt
1 442a	(A/E 22) 	B/E ii 45 	(A/E 41) 	(B/E i 52)
2 442b				

	W	An	N	Nt
3 442c	A/E 23 			

(© 04 1901) ...





W'	W	An	Nt
			

4
443a

5 An
One group blank at sic

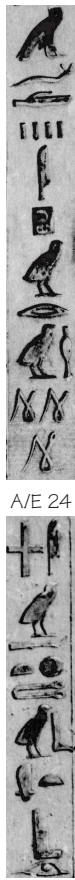
5 Nt
For first two signs
in B/E i 54 read



W	An	N	Nt
			

5*
443b

(A/E 42)

B/E ii 46

B/E i 54

A/E 24

sic

6
443c

→ PT 295

→ PT 295

→ PT 295

1
444a

W	T	N
(A/E 24)	(A/E 11)	(A/E 57)

2
444b

3
444b-c

W	T	N
A/E 25		

4
444d

5*
444e

W	T	N

5 N

For first sign read

PT 300

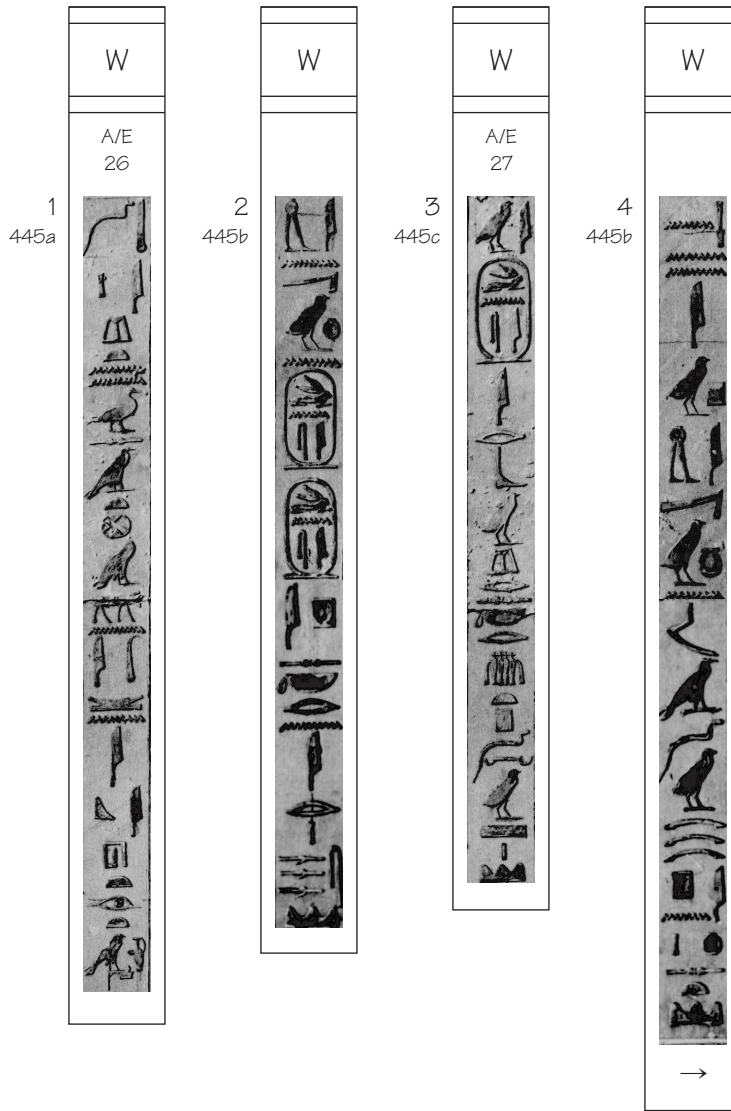

	W	T	P	An	M	N
1 446a	(A/E 27) 	(A/S A 10) //// ...	(A/S 14) 	(B/E i 28) 	A/E 1 (fr. Or N) //// ... (lost to 21)	A/E 1 //// ...
2 446b			(S 01 4501) ... 			
	A/E 28 					

4
Apparently an additional phrase in T, and perhaps N

	W	T	An	N
3 446c				
4* 446d				
		... //// ...	B/e i 29 ... //// //// ...
		A/S A 11 ... //// //// //// ...

5
447a

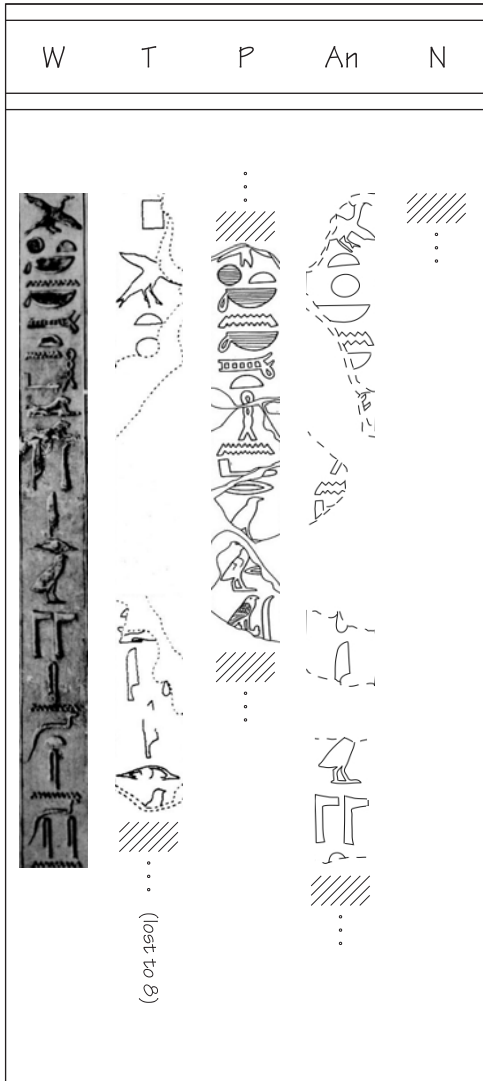

6
447b

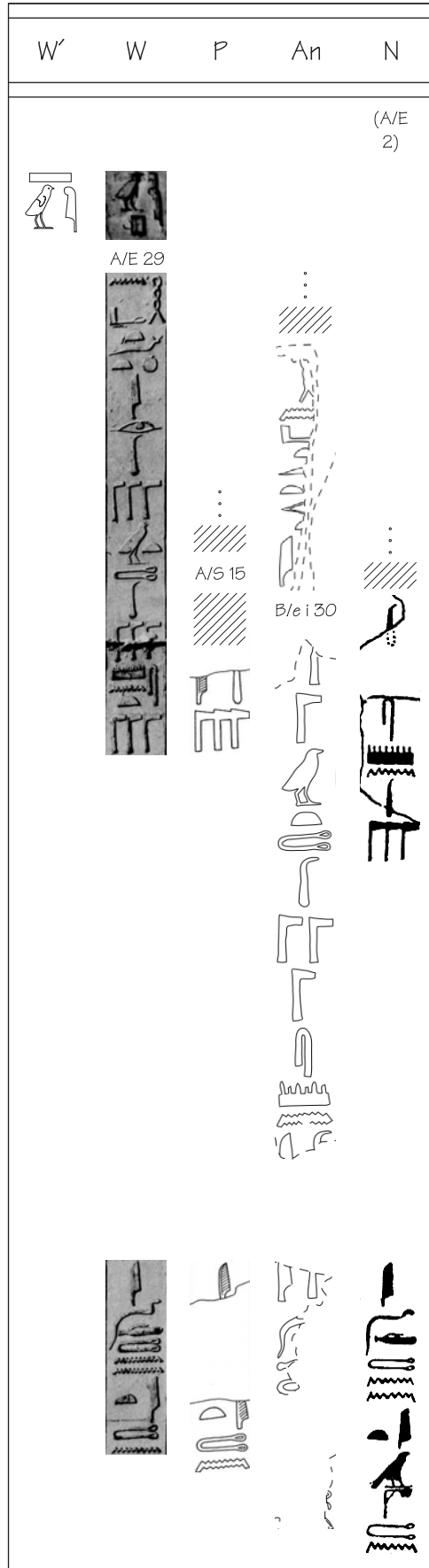

7
448a

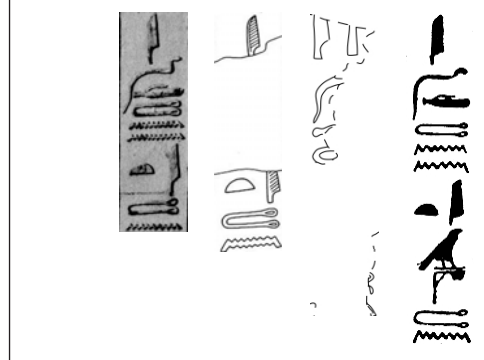

8
448b

W'	W	T	P	An	N
		(A/S A 12) 			









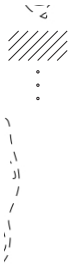

9
448c

W'	W	An

	W	T	P	An	N
10 449a					(A/E 3)
11 449a					
12 449b					













	W	T	An	N
13 450a				

14
450b











W'	W	T	P	An	N
					
	A/E 31 				
					
			A/S 16 		











15
450b

16
450c

W	T	P	An	N
				
			B/e i 33 	
				
				A/E 4 
				

17
451a









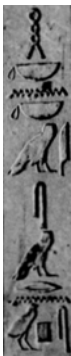

	W	T	P	An	N
18 451b					
	A/E 32	A/S A 14			
19 451c					
			B/e 134		

	W	T	P	An	M	N
20 452a						
					(A/E 6)	
21 452b						
					(lost to 29)	

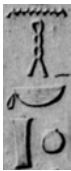



	W	T	P	An	N
22 453a					
	A/E 33 			...	
				...	
			A/S 17 	...	
23 453b					
				A/E 5 	...

	W	T	P	An	N
24 454a					
	
			

25*
454b

W	T	An	N
			
A/E 34			
			











26
454c

			
---	---	---	---



25 N

Last sign probably 

27
455a

W	T	P	An	N
				
				

28
455b

				
---	---	--	---	---

B/E
i 36

29
455c

W	T	P	An	M	N
				(A/E 7)	
				...	
				(lost to 35)	
A/E 35					A/E 6

30
456a-b

W	T	P	An	N
	(A/S A 17)			
		B/E i 37		
		...		
		(lost to 35)		

31
456c

W	T	P	An	N

32
456d-e

W	T	An	N
A/E 36			
	B/E 138		

33
457a







W	T	An	M	N
	(92 01 1501)		(A/E 8)	
			(1501 1502)	
			*779	

(PT 301)





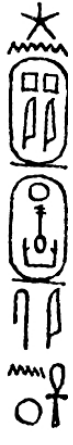

	W	An	N
34 457b			A/E 7

	W	T	P	An	N
35 457c		(A/S A 18) 			
36 457c			B/E I 39 		
	end	end	→ PT 706	→ PT 473	→ PT 421

PT 302

	W	T	P	N
	A/N 1	A/N 1	(A/N 7)	(B/Se B 91)
1 458a		//// ...	//// ...	
2 458a		//// ...		 B/Se B 92
				//// ...

3
458b-c

	W'	W	T	P	N
					
			//// ...		
					









	W	T	P	N
4 458d				
5 458d	A/N 2 			
6 459a				











	W	T	P	N
7 459a				
8 459b				







	W	T	P	N
9 460a	A/N 3 			B/Se B 93
10 460b				
11 460b				

	W'	W	T	P	N
12 460c					
13 461a					
14 461b		A/N 4 			

(G1 01 450)

	W	P	N
15 461c			
16 461d		 B/Se B 94 ...	
17 462a			

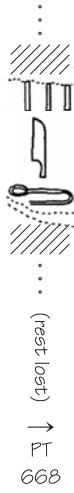
	W	T	P	N
18 462b	 A/N 5	(A/N 4) ...	 A/N 8 ...	
19 462c				
20 462c				







W	T	P	N
			
			

21
463a

22*
463b

→ PT
668
(1501 1521)

B/Se B 95

W	P	N
		
		

23
463c

24
463d

A/N
6

→

→ PT
*751

→ PT
669

22 W

Body of  erased

Pieces of  added in paint

	W	T	P	N	Wd
5 465b		A/N 43 	 ... (rest read) PT *752		
	A/N 8 			A/N 19 	
6 465c					B/E A.9

	W	T	N	Wd
7 466a				
			A/N 44 	
8 466a				
9 466b				

	W	T	N	Wd
10 467a				
	A/N 9 	... A/N 45 		
11 467b				
	 B/E A 10 	







	W	T	N	Wd
12 467c				
	
	→	→ PT 309	→ PT 685	→ PT 324

	W	T	P	N	Wd
1 468a	(A/N 9) 	(A/N 36) //// ...	(A/N 50) //// ...	(A/N 16) 	(B/E A 4)
	A/N 10 				
2 468b		... //// A/N 37 //// //// 	B/E A 5 ... //// 	... ////

	W	T	P	N	Wd
3 468c			 ... //// A/N 51 //// ...		
4 469a			... //// 	A/N 17 	... ////

(lost to 7)









5
469b

W	T	N	Wd
A/N 11	(A/N 38)		
			
			

6
470a

B/E A 6

7
470b

W	T	P	N	Wd
	A/N 39			
				
				

8
470c

A/N 52

A/N 12

	W	T	P	N	Wd
9 471a		... A/N 40 ...			
10 471a		... 			
11* 471b	

	W	T	P	N	Wd
12 471c				A/N 18 	
	 	
		... A/N 41 ...			
		... 			

11 N

altered to

(PT 304)

	W	T	P	N	Wa
A/N 13					
13 471d					
					
	→	→	→ PT 324	→ PT 303	→ PT 303

	W	P	N	Nt
	(A/N 13)	A/N 46	(A/N 13)	CW 22
1 472a				
2 472b				
	A/N 14	...		
3 472c				

	W	P	N	Nt
4 472d				
			CW 23	
5 472d				

	W	P	N	Nt
6 473a	A/N 15 			
7 473a				
8 473b		A/N 47 	A/N 14 	C/W 24

	W'	W	P	N	Nt
9 473c					
10 474a		A/N 16 			
11 474b					

... (lost to 13)

C/W 25

1*
476a

W'	W	M	N
	A/N 18	V/N 8	(V/E 70)

2
476b

3
477a

W	M	N
A/N 19		

4
477b









5
477c

1 N
Text of PT 306 includes
fig. 15 frs. d/e

6
478a

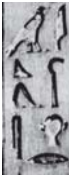
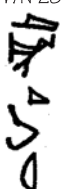
W'	W	M	N

7*
478b

W'	W	M	N
		 VN 21	
		 VN 22	
		 VN 23	
		 VN 24	















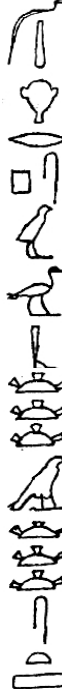

8
479a

9
479a

7 W

 above king's name
added in paint

10
479b

W	M	N
	 VN 25	
	 VN 26	
	 VN 27	 VE 73
	 VN 28	
	 VN 29	
	 VN 30	











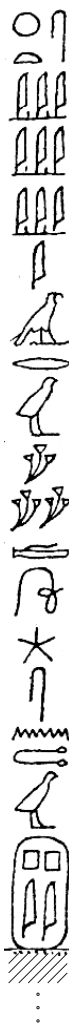

11
480a

12
480b

A/N 21

A/N 22



13
480c

W	M	N
	 VN 31	
	 VN 32	
	 VN 33	
	 VN 34	
	 VN 35	

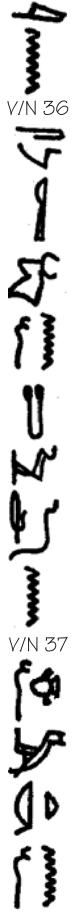

14
480d

(PT 306)

15
481a

W	M	N
A/N 23		
		<p>...</p>  <p>...</p> 
	V/N 36	V/N 37

16
481b

W	M	N
		V/E 74
		
		A/N 24
		

17
481c

18
481d

W	M	N
		<p>...</p> 
	PT 619	PT 699

	W	P
1 482a	A/N 25	V/W 51
2 482b		
3 482c	A/N 26	

	W	P
4 483a		
5 483b		
6 483b-c	A/N 27	

	W'	W	P
7 484a-b			
8 484c		A/N 28	V/W 52

	W	P
9 484d		
10 485a	A/N 29	

(PT 307)

	W	P
11 485b		
12 485b		
13 485c		
14 485c		

A/N 30

	W	P
15 486a		
16 486b		

V/N 53

	W	P
17 486c		
18 486d		

A/N 31

→

→
PT
574

1
487a

W	T	P	N	Nt	Wd
(A/N 31)	A/N 32	(A/N 48)	A/N 15	(C/W 26)	(B/E A 2)
	//// ...	//// ... (lost to 5)			//// ...
A/N 32			C/W 27
 //// ... (lost to 5)

2
487b



3
487c

W	T	N	Nt
	A/N 33		
	//// ...		
		C/W 28	
	... 		

4
488a

















	W	T	P	N	Nt	Wd
5 488b	A/N 33 	(A/N 34) 	(A/N 49) 			
6 489a						

	W	T	P	N	Nt	Wd
7 489b		A/N 35 				

	W	T	P	M	N
1 490a	(A/N 34) 	(A/N 45) 	(A/S 4) 	(B/Sw i 3 fr. Or J) 	(B/S e B 89)
2 490b	A/N 35 	A/N 46 		(lost to 6) 	
3 490c				B/S e B 90 	

	W	T	P	N
4 491a				
5 491b			A/S 5 	

(PT 309)

	W	T	P	M	N
				(B/Sw i 4 fr. Or J)	
6 491c					
A/N 36					
7 491d					
→	→	→	→	→	→
	PT 585	PT 267	PT 665B	PT 668	

	W	T	P	An	M	N
1 492a	(A/N 36) 	(A/N 15) 	(A/W 50) 	(B/E i 18) 	A/Wg 49 	(A/N 51)
2 492b						

	W	T	P	An	M	N
3 492c		(A/N 16) 				
4 492d						

	W	T	P	An	M	N
5 493a						
6* 493a						

	W	P	An	M	N
7 493b- 494a					
A/N 38					
A/Wg 53					
A/N 53					

6 N

Sethe saw at break



	W'	W	P	N
7 497b				
8 497b-c				
9 497c				
		A/N 41	VE 31	VE 14

	W	P	N
10 498a			
11 498b			

	W	P	N
12 499a			
13 499b			

(PT 311)

PT 312

14
499c

W	P	N

15
500a

16
500b

W	P	N

17
500c

18
500d

W	P	N
→	→ PT *761	→ PT 574

501

W'	W

PT 313

PT 314

PT 315

W

C/W 1

1 502a

2 502b

3 502b-503a

C/W 2

W' W

4 503a

C/W 3

5 503b

6 503b

→

W

(C/W 4)

1 504a

C/W 5

2 504b

→

W

(C/W 5)

1 505a

C/W 6

2 505b

C/W 7

W' W

3 505c

C/W 8

→

PT 316

	W
	(C/W 8)
1 506a	
	C/W 9
2 506b	
	C/W 10
3 506c	
	→

	W
	(C/W 10)
1 507a	
	C/W 11
2 507b	
	C/W 12

	W
	C/W 13
3 507c	
	C/W 14
4 508a	

	W
	C/W 15
5 508b	
	C/W 16
6 509a	
	C/W 17
7 509b	

	W'	W
8 509c		
	C/W 18	
9 510a		
	C/W 19	
10 510b		

	W
11 510c	
	C/W 20
12 510d	
	end

	W	Ta	Tb
	C/E 1	(A/E 14)	A/E 16
1 511a			
	...		
2* 511a-b			
	C/E 2		



2 W
Space for three
determinatives after

2 Tb
Space for of nḥwt
uncarved

	W	Ta	Tb
3 511c			
	C/E 3		sic
4 511d			

	W	Ta	Tb
5 512a	C/E 4		
6* 512b			
	C/E 5		

6 Ta
Space for uncarved
before first

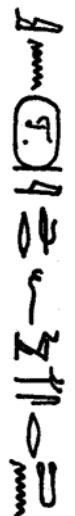
W	Ta	Tb
 C/E 6		

7
512c

W	Ta	Tb
		

8
512d

→

→
PT
318
(T^b)



→
PT
383

	W	W	W	W	W	W
1 513a	(C/E 6) 	4 513c 	5* 513d 	6 514a 	7 514b 	9 514d
	C/E 7 	C/E 9 	C/E 10 	C/E 11 	C/E 12 	C/E 13
2 513b					8 514c 	10 514e
3 513b	C/E 8 		5 altered from a sign like			
						→

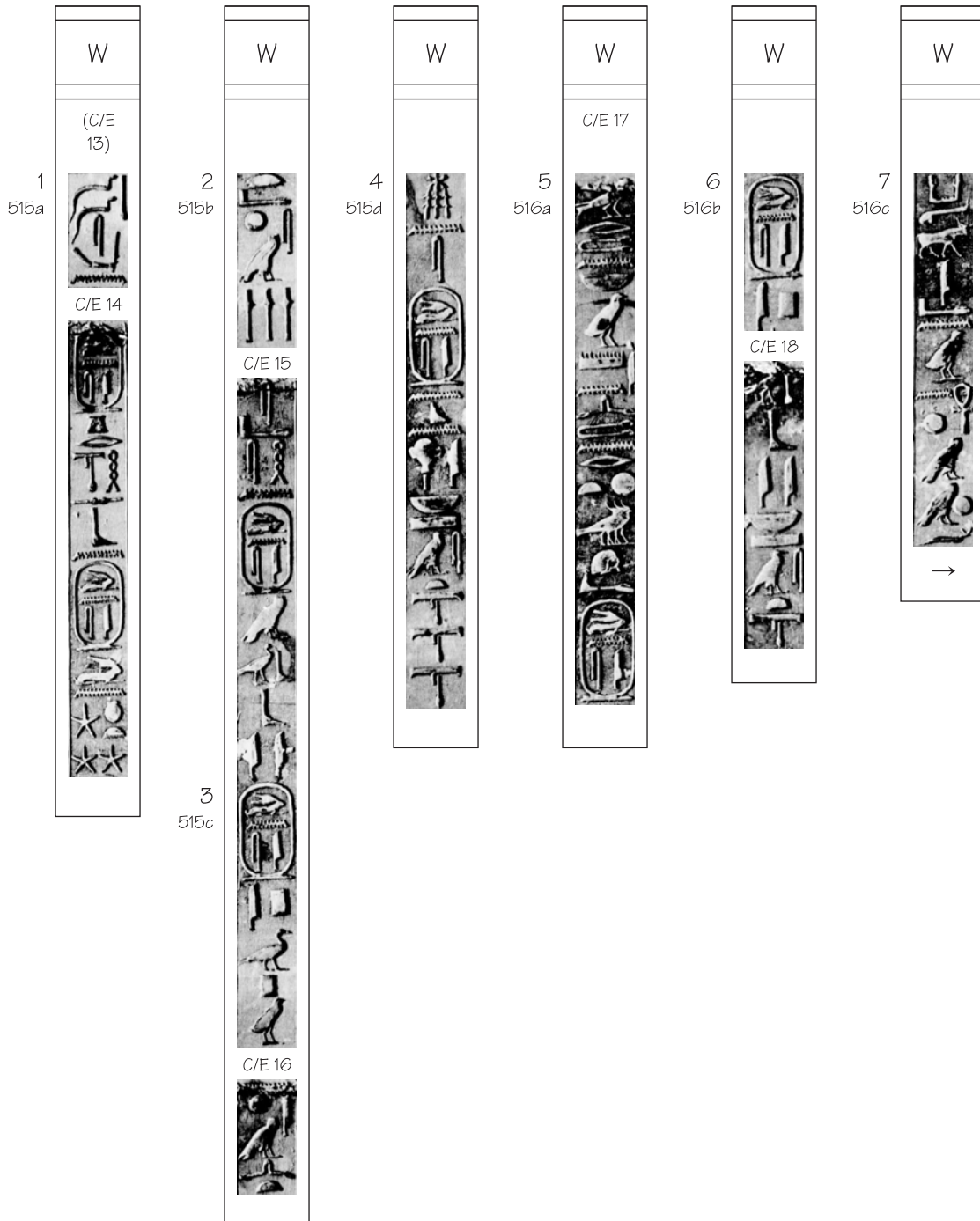









PT 320



1
517a

W	P	An	N	Nt
C/E 19	(APh/W 12)	(B/E i 14)	(B/Nw ii 19)	B/Nw 17
				
C/E 20 				

2
517b

W	P	An	N	Nt
				
				
end	→ PT 474	→ PT 561A	→ PT 574	→ PT 474

5
518d

T	P''	P'	P	N
 →		 → PT 512	 end	

1
519a

T	P	M
(B/Wg 7)	Cm/E 1	(Cm/W 71)
B/Wg 8		

2
519b

T	P	M
B/Wg 9		
	Cm/E 2	

3*
519c

T	P	M
B/Wg 10		
	→ PT 503	→ PT 525

3 M

First M is prenomen, second is nomen

1
520a

T	P	Nt	Wd
(B/Wg 10)	(A/N 52)	(C/W 31)	(B/E A 10)

2 T

½ group uncarved before rn

4 Wd

Second sign after break is

2*
520b

T	Nt	Wd

3
521a

end

4*
521b

T	P	Wd
		(B/E A 12)

5
521c

T	P	Wd

B/Wg 14

B/E A 13

(6 01 1501) ... (lost to 9)

7
522a

T	Wd

B/Wg 15

8
522b

9
522c

T	P	Wd

B/Wg 16

(lost to 13)

B/E A 14

10
522d

T	Wd

B/Wg 17

11
523a

6
521d

12
523b

T	Wd

13 T
First preserved sign in B/Wg 18 is probably (of rd) rather than Sethe's

14 T
 altered from

13*
523c

T	P	Wd

A/N
54

B/Wg 18

(G1 01 4501)

B/E A 16

15
524b-c

T	P	Wd

B/Wg 19

16
524d

T	P	Wd

*1 Fragmentary text follows in B/E A 16-20, then PT *756

1
525a-b

T	P
B/Wg 20	(APs/W 16)

2
525c

--	--

3
526a-b

T	P
APs/W 18	

4
526c

--	--

5
527a-b

T	P

6
527c

--	--

7
528a-b

T	P

8
528c

--	--

9
529a-b

T	P

10
529c

--	--

11*
530a

T	P
APs/W 23	
...	
B/Wg 26	
...	
APs/W 24	
...	

11 P

Sethe saw legs of initial 

13
531a

T	P
B/Wg 27	
APs/W 25	
...	

14 T

Second  an emendation

16
532a

T	P
B/Wg 28	
APs/W 26	
...	
B/Wg 29	
APs/W 28	
...	
B/Wg 30	
APs/W 27	
...	

17
532b

18
533a

T	P
B/Wg 29	
APs/W 28	
...	
B/Wg 30	
APs/W 30	
...	

20
533c

21
533d

T	P
B/Wg 30	
APs/W 29	
...	
B/Wg 30	
APs/W 29	
...	
B/Wg 30	
APs/W 29	
...	

22*
533e

22 T

First three signs of B/Wg 30 after Maspero

T	N
(B/Wg 30)	(B/Nw iii 29)
1 534a	1 534a
→	end

2
534b

B/Nw
iii 30

1
535a

T	P	N
(B/Wg 30)	(B/Gw A 1)	B/Nw iii 13
 (lost to 3)	
B/Wa 31		B/Nw iii 14

2
535b

T	N
	B/Nw iii 15
	B/Nw iii 16

3
535c

T	P	N
	(B/Gw A 2)	B/Nw iii 17
	...	B/Nw iii 18
		B/Nw iii 19
		B/Wg 32

4
536a

5
536b

T	P	N
	(B/Gw A 3)	B/Nw iii 20
	...	B/Nw iii 21
		B/Nw iii 22
→	→ PT 670	→ PT 330

6
536c

	T	P	M
	(B/Wg 32)	(A/S 22)	(A/S 7) (fr. Or G)
1 537a			
	B/Wg 33		
2 537b			
			... (read) ... PT *736

	T	P
3 537b		
	B/Wg 34	
		→ PT *705

	T
1 538a	
2 538b	

	T
3 538c	
4 538d	

1
539a

T	N	Nt
(B/Wg 35)	B/Nw iii 23	(B/Nw 4)

2
539b





2
540a

T	N	Nt
(B/Wg 36)	(B/Nw iii 25)	(B/Nw 5)

	T	M	N
1 541a	(B/Wg 37)	(B/W 47)	(B/W 62)
2 541b	B/Wg 38		
3 541c			B/W 63





	T	M	N
4 541d	B/Wg 39		
5 541e	→ PT 440	→ PT 440	→ PT 622

1
542a

T	P	N
B/Wg 40	(Cm/W 72)	(A/S F)
		
	Cm/W 73	
		
		

2
542b

3
542c

T	P'	P	N
			
B/Wg 41			
			
→		→ PT 514	end

	T	Jp
1* 543a	(B/Wg 41)	B/W 8
2 543b		
	T	
3 543c		
	T	
4 543c		
	T	
5 544a		
	T	
6 544c		
	T	
7 545a		
	T	
8 545b		
	T	
9 545c		

1 Jp
 For second sign
 read
 For last sign
 read

1*
546a

T	P	M	N
(B/Wg 46)	(B/W 24)	(B/Wg 51)	B/Wg 37
B/Wg 47		B/Wg 52	

1P

Original text in B/W 63, erased:

2
546b

T	P	M	N
B/Wg 48	B/W 25		

3
546b

4
546c

























































T	P	M	N
		B/Wg 53	
→	→ PT 439	→	→ PT 423

	T	P	N
	(B/Wg 53)	A/W 1	(Cn/E 46)
1 549a			
	B/Wa 54		Cn/E 47
2 549b			

	T	P	N
3 550a			
	B/Wg 55		
4 550b			
	B/Wa 56		Cn/E 48





	T	P	N
5 550c			
	B/Wg 57		
	B/Wg 58		
	end	→ PT 363	→ PT *795

1
551a

T	M	N
B/Eg 1	(B/E 23)	B/Eg 1
		
		
		
		
		
		
		
		
		
		
		
		
		
		
		
		
		
		
		





































































2
551b

3
551c

T	M	N
		
		
		
		
		
		
		
		
		
		
		
		
		
		
		
		
		

4
551d

5
551e

T	M	N
		
		
		
		
		
		
		
		
		
		
		
		
		
		
		
		
		
		
		
		
		
		
		

6
552a

	T	M	N
1 553a	B/Eg 9	(B/E 26)	(B/Eg 11)
3 553a	B/Eg 10	B/E 27	B/Ea 13

	T	M	N
3 553c	B/Eg 11		
4 553d			B/Eg 14



←
PT
210







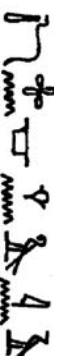

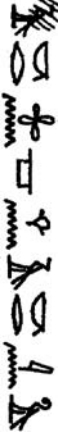
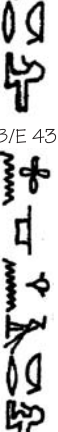
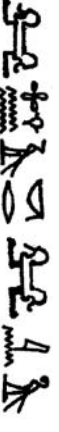
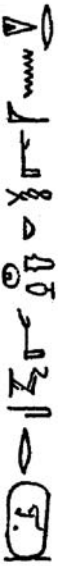
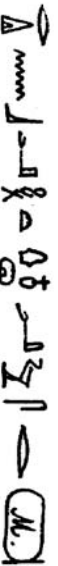
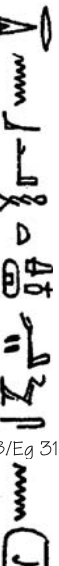



←
PT
210

←
PT
210

	T	M	N
	(B/Eg 27)	B/E 41	(B/Eg 29)
1 554a			
2 554b			
	B/Eg 28		
		B/E 42	

	T	M	N
			B/Eg 30
3 554c			
4 554d			

	T	M	N
1 555a	B/Eg 29 	(B/E 42) 	(B/Eg 30) 
		B/E 43 	
5 555b			B/Eg 31 

	T	M	N
3 555c			
4 555d	B/Eg 30 		
		B/E 44 	
6 555e			
	→	→	→

1
556a

T	M	N
(B/Eg 30)	(B/E 44)	(B/Eg 31)

2
556b

3
556c

T	M	N

4
557a

5
557b

6
557c

T	M	N

PT 343

1
558a

T	M	N
(B/Eg 32)	(B/E 46 + fr Or L)	(B/Eg 33)
B/Eg 33		
		B/Eg 34
→	→	→

2
558b

PT 344











1
559a-b

T	M	N
(B/Eg 33)	(B/E 46 + fr Or L)	(B/Eg 34)

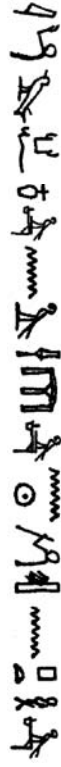
2
559c

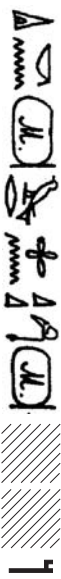
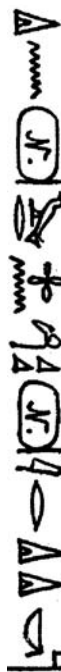

























T	M	N
B/Eg 34		
	B/E 47	
→	→	→

1
560a-b

T	M	N
(B/Eg 34)	(B/E 47 +fr Or L)	B/Eg 35
		
		
		
		

2
560c













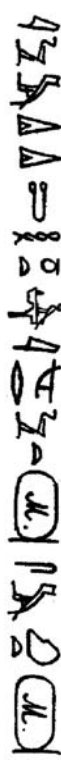

1
561a

T	M	N
B/Eg 35	(B/E 47 +fr Or L)	(B/Eg 35)
		
		
		
		
		
		
		
		
		

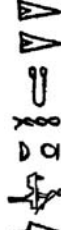
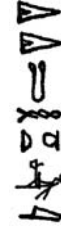
2
561b

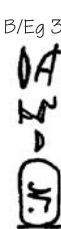
3
561c

3
561d

T	M	N
		
		
		
		
		
		

4
562a





B/Eg 37

B/F 48



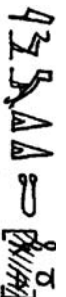



B/Eg 36

B/Eg 36

6
562b-c





T	M	N
B/Eg 37		
		
		
→ PT 208	→ PT 208	→ PT 400

1
563a

T	N
B/Eg 39	(B/Eg 45)
	
	
	B/Eg 46
	
	B/Eg 40
	



563b

3
563c

T	N
	
	
	B/Ea 47
	
	B/Eg 41
	

5
564a

6
564b





T	N
	B/Eg 48
	
→	→

1
565a-b





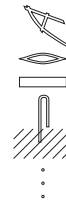















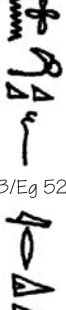

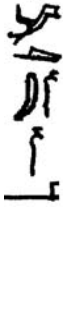





T	P	M	N
B/Eg 42	APs/E 1	(B/E 49 +fr Or L)	(B/Eg 48)
			
			
			
			
			
	APs/E 2		B/Eg 50

2
565c

3
565d















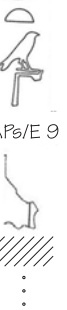

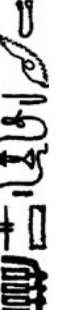





































































T	P	M	N
			
→	→	→	→

1
566a-b













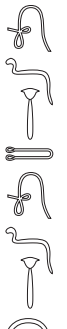





























































T	P	M	N
B/Eg 44	(APs/E 2)	(B/E 49)	(B/Eg 50)
			
			
			
			
			
			
			
			
			
			
			
			
			
			
			
→	→ PT 206	→	→ PT 206

2
566c









1
567a-b

T	P	Sethe	M
(B/Eg 45)	(APs/E 8)		(B/E 50 +fr Or L)
			
			
			
			
			
			
			
			
			
			
			
			
			
			
			
			
			
			
			
			
			
			

2
567c

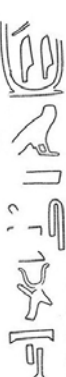
T	P	M
		
		
		
		
		
		
		
		
		
		
		
		
		
		
		
		
		
		
		
		
		
		
		
		
		

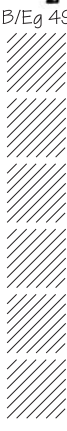
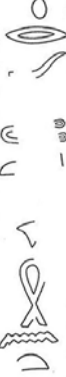
1
568a-b

T	P	M
B/Eg 48	(APs/E 10)	(B/E 50)
	⋮ 	 ⋮
		⋮ 
B/Eg 49		B/F 51
		

2
568c

T	P	M
		
	APs/E 11 	
B/Eg 50		
		
↑ PT 353	↑ PT 405	↑ PT 353



1
569a-b

N
(B/E 54)

*1

PT 405 follows, continued from B/Eg 62 (end of B/Eg)

2
569b

N

B/E 55

*1



3
569d

	T	P	M	N
	B/Eg 51	(APs/E 15)	(B/E 51 +fr Or L)	(B/E 56)
570*				
	B/Eg 52	APs/E 16		
				
	→	→ PT 401	→ PT 400	→ PT 401

P PT 401 follows as part of the same spell

354.2

Last column covered by roof slab

	T
	(B/Eg 52)
1 571a	
2* 571b	B/Eg 53 
	B/Eg 54 
	...
	...
	end

	T	P	M	N
	B/E ii 18	(B/E 20)	(B/Eg 44)	(B/E 41)
1 572a		_____	_____	_____
	B/E ii 19	_____	_____	_____
2 572b-c				
	B/E ii 20	...	B/Eg 45	B/E 42
	B/E ii 21

	T	P	M	N
	B/E ii 22			
3 572d				
	B/E ii 23	...	B/Eg 46	...
	B/E ii 24
4 572e				
	B/E ii 25
	B/E ii 26

	T	P	M	N
	B/E ii 27			
5 573a				
	B/E ii 28	...	B/Eg 47	...
	B/E ii 29
6 573b				
	B/E ii 30	B/E 21	...	B/E 43
	B/E ii 31

T	P	M	N
		B/Eg 48	
7 573c			
8 573c-d			
9 574a			

T	P	M	N
		B/Eg 49	
10 574b			
	B/E ii 32		
11 574c			
		B/E 44	

T	P	M	N
		B/Eg 50	
12 574d			
	PT 461	PT 459	PT 595

	T	pa	pb	M	N	Nt
	(B/E ii 32)	(B/W 53)	B/E 1	(B/Eg 20)	(B/W 35)	(B/W 37)
1* 575a						
				B/W 36		
	B/E ii 33					
				B/Eg 21		
2 575b						

1 pb
On this wall, altered to

	T	pa	pb	M	N	Nt
						B/W 38
3 575c						
4 576a						
5 576a-b						
	B/E ii 34					
						B/Eg 22

T	pa	pb	M	N	Nt
B/W 54					
B/W 37					
B/W 39					













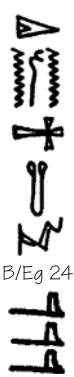

6
576c

7
577a

T	pa	pb	M	N	Nt
B/E 2					
B/Ea 23					
B/E ii 35					



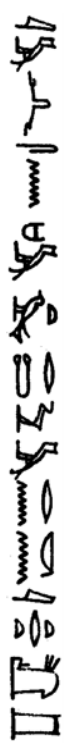













8
577b

9
577c

T	pa	pb	M	N	Nt
					
				 B/W 38	 B/W 40
					 B/Eg 24
					
					
					

10
577d

11
578a

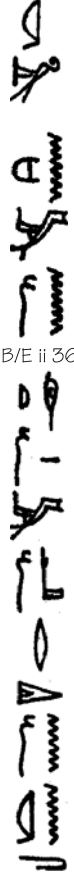
T	pa	pb	M	N	Nt
					
					
					
					
	 ...	 ...	 ...		 B/E ii 36
					

12
578b

13
578c

14
578d

19
580c

T	pa	pb	M	N	Nt

20
581a

21
581b

T	pa	pb	M	N	Nt







22
581b

B/W
56

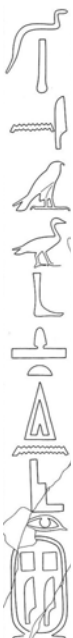
B/W 41

B/W 43

B/Eg 27

	T	pa	pb	M	N	Nt	Wd
	(B/E ii 38)	(B/E 4)	(Cn/E 26)	B/Eg 29	(B/E 4)	(B/W 51)	(B/W 38)
1 583a	_____	_____		_____	_____	_____	//// ...
2 583a-b	 B/E ii 39		 Cn/E 27			 B/W 52	

	T	pa	pb	M	N	Nt	Wd
							(B/W 39)
3 583c							
4 584a							

3
583c

4
584a

(B/W 39)

B/E 5

B/E 5

Cn/E 28

T	pa	pb	M	N	Nt	Wd
<p>5 584b</p>		<p>Cn/E 29</p>			<p>B/W 53</p>	<p>(B/W 40)</p>
<p>6 584c</p>			<p>B/Eg 30</p>			

	T	pa	pb	M	N	Nt	Wd
							(B/W 41)
7 585a			 Cn/E 30				
8 585b						 B/W 54	

	T	pa	pb	M	N	Nt	Wd
9 585c							
10 585d							
11 586a							

9
585c

10
585d

11
586a

Cn/E 31

B/Eg 31

B/E 6

B/E ii 41

12
586b

T	pa	pb	M	N	Nt	Wd
	B/E 6					(B/W 42)
		Cn/E 32 				
					B/W 55	

13
587a

	T	pa	pb	M	N	Nt	Wd
							(B/W 43)
14 587b							
15 587c							

B/Eg 32

Cn/E 33

B/E ii 42

Wd	Nt	N	M	pb	pa	T
<p>sic?</p> <p>B/W 44</p> <p>...</p>	<p>B/W 56</p>			<p>Cn/E 34</p>		









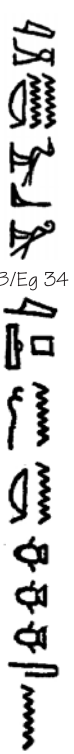
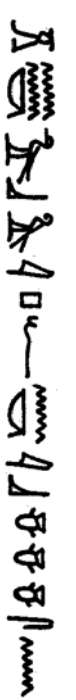

16
588a

17
588b

	T	pa	pb	M	N	Nt	Wd
18 588c				 B/Eg 33			
19 589a	 B/E ii 43		 Cn/E 35		 B/E 7		 B/W 45

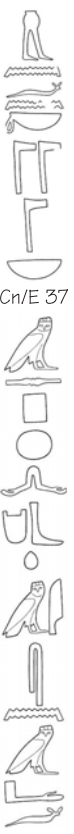
	T	pa	pb	M	N	Nt	Wd
20 589b		 B/E 7					
21* 590a			 Cn/E 36			 B/W 57	

21 M □ added secondarily

	T	pa	pb	M	N	Nt	Wd
<p>22 590b</p> 			<p>B/Eg 34</p> 			<p>B/W 46</p> 	
<p>23 590c</p> 		<p>Cn/E 37</p> 					

24
591a

T	pa	pb	M	N	Nt	Wd
						 B/W 47 ...
		 Cn/E 38	 B/Eq 35			

24 Wd For first sign read

26*
591c

T	pa	pb	M	N	Nt	Wd
	 B/E 8		 B/E 8	 B/E 8		
 B/E ii 45		 Cn/E 39				
 28* 592a					 sic	 B/W 48 ...

26-27 P^b

26-27 Wd

28 P^b 30 follows

1
594a

T	P	Sethe	N
P/N 1	(V/W 45)		(Cn/E 21)

2
594b

3
594c

T	P	N
P/N 2		Cn/E 22

4
594d

5
594e

T	P	N
P/N 3		

6
594f

Cn/E 23

V/W 46

7
595a

T	P	N

8
595b

P/N 4

Cn/E 24

9
595c

T	P	N

10
596a

P/N 5

Cn/E 25

11
596b

T	P	N

V/W
47

12
596c

P/N 6

Cn/E 26

13
597a

T	P	N

14
597b

T	P	N

15
597c

T	P	N

16
598a

T	P	N

17*
598b

T	P	N

18
598c

T	P	N

17 P
In lacuna, read
First 3 signs
after Maspero,
last after
Sethe



19
599a

T	P	N

20
599b

21
599c-d

T	P	N

22
600a-b

T	P	N

23
600c

T	P	N
<p>24 601a</p>	<p> Cn/E 32 </p>	<p> P/N 13 </p>
<p>25 601b</p>		

T	P	N	Sethe
<p>26 601c</p>	<p> VW 49 </p>	<p> Cn/E 33 </p>	
<p>27 601d</p>	<p> P/N 14 </p>		

T	P	Sethe	N
<p>28 601e</p>			<p> Cn/E 34 </p>
<p>29 601f</p>			<p> P/N 15 </p>

30
602a

T	P	N

31
602b-c

T	P	N
	P/N 16	Cn/E 35
		...
		→ PT 535
		→ PT 307

1
603a

T	N
(P/N 16) 	(P/S 25)
P/N 17 	

2
603b

3
603c

T	N
P/N 18 	P/S 26

4
603d

T	N
(P/N 18)	(P/S 26)
1 604a	
2 604b	
3 604c-d	
	P/N 19

T	N
	P/S 27
4 604e	
	P/N 20
	5 604f
	end
	→

T
(P/N 20)
1 605a
P/N 21
2 605b

T
P/N 22
3 606a
4 606b-c

T
P/N 23
5 606d
→

1
607a-b

T	P	An	M	N
P/N 24	(A/W 1)	(B/E ii 40)	A/E 12 (fr. Or M+N)	(A/E 27)

2
607c

T	P	An	M	N
P/N 25		(last to 6)		

3
607d

--	--	--	--	--

4
608a

T	P	An	N
	 A/W 2	 B/E ii 41	 (A/E 28)

5
608b

6
607c

T	P	An	M	N
			 (A/E 13)	
end	→ PT 466	→ PT 240	→ PT 406	→ PT 406

1
609a

T	P	An	M	N	Jp
(A/W 28)	B/Sw B 1	B/E i1	(A/Eg 40)	(A/E 9)	(B/E 16)
	/// ... (lost to 27)	/// ... 		/// ...	/// ... (lost to 18)
609b	 	

3
609b-c

T	An	M	N
			A/E 10
			/// ...
	... 	A/Eg 41 	...
4 609c	... 		
5 610a	... 	B/E i 2 	
A/W 29 	... 		

6
610b

T	An	M	N

7
610c

T	An	M	N

8
610d-
611a

T	An	M	N

9
611a

T	An	M

10
611b

T	An	M

11
611b

T	An	M

12*
612a

T	An	M	N

13
612a

T	An	M	N

14
612b

T	An	M	N

- 12 An Initial lacuna contained *jsjr 'nhj-n.s-PJPJ*
- 12 M Besides the of *jsjr*, lacuna may have contained nothing, rather than one of the usual two king's names
- 12 N Feet are probably those of *gm* bird rather than Jéquier's





	T	An	M	N	Jp
15 613a					(B/E 18)
16 613a					
17 613b					
18 613b					

	T	An	M	N
19* 613c				
20 614a				

19 M Probably nothing lost at end of column other than





21
614b

22
614c







T	An	M	Jp
A/W 31			(B/E 19)
			

23
614d







24
615a

T	An	M	N	Jp
			A/E 12	
				







25
615b

T	P	An	M	N	Jp
	(B/Sw B 19)				(B/E 20)
					

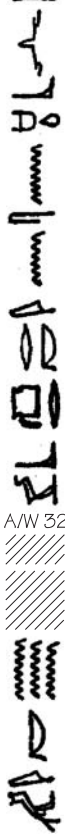
26
615c

T	P	An	M	N	Jp
					

27
615d

T	P	An	M	N	Jp
					

28
615a-b

T	P	An	M	N	Jp
					(B/E 20)
					

29
615c

T	P	An	M	N	Jp
					

30
616b

T	P	An	M

31
616e

--	--	--	--

32 Jp For read probably

32*
616f

T	P	An	M	N	Jp

33
617a

--	--	--	--	--	--

(B/E 21)

B/E i 8

A/Eg 52

A/E 13

B/E 22

A/W 33

34
617b

T	P	An	M	N	Jp

35
617c

36
618a

T	P	An	M	N	Jp

37
618b

A/Eg
54

B/E
23

...
B/Sw B
24
... (rest lost)
end

B/E i 9

A/Eg 55

...
A
...

38*
619a

T	An	M	N	Jp

39
619b

38 N
Final clause (nj ntr mrwtj.k) omitted.

40
620a

T	An	M	N	Jp

41
620b

42
620c

T	An	M	N

43
621a

--	--	--	--

44
621b

T	An	M	N	Jp

45
621c

--	--	--	--	--

→

→
PT
441

end

→
CT
516

→
PT
677

1
622a

T	P	M	N
(A/W 35)	B/Wg 22	(B/Wg 32)	(B/W 52)

2
622b

3
622b

4
622c

5
622d

6
623a-b

T	P	M	N

7
623c

8
624a

9
624b

T	P	M	N

10
624c

T	P	M	N

11
625a

T	P	M	N

12
625b

T	P	M	N

13
625c

T	P	M	N

14
625d

T	P	M	N

PT
373

1
626a

T	P	M	N	Wa
(A/W 37)	(B/Wg 25)	(B/Wg 36)	(B/Wh 13)	(B/W 48)
<				

6
627b

T	P	M	N	Wd
				(B/W 51)

7
628a

--	--	--	--	--

8
628b

--	--	--	--	--

B/Wg 38

9
628c

T	P	M	N	Wd
				(B/W 52)

A/W 39

B/Wg 28

10
629a

--	--	--	--	--

B/Wh i 5

11
629b

--	--	--	--	--

12*
629c

T	P	M	N	Wa
		 B/Wg 39		 ...

13*
630a

	 B/Wg 29		
--	-------------	--	---------	---------

12-13 N



14
630b

T	P	M	N	Wa
 A/W 40				 (B/W 53) ...

15
630c

		 B/Wg 40		
--	--	-------------	--	--

19
632b

T	P	M	N	Wa

20
632c

T	P	M	N	Wa

21
632d

T	P	M	N	Wa

B/Wg 31

→

...
B/W 56
...

22
633a

T	P	M	N	Wa

23
633b

T	P	M	N	Wa

→

→
PT
423

→
PT
371

→
PT
336

→

1*
634a

T	P	M	N	Nt	Wd
(A/W 41)	B/Wh 1	B/Wg 24	(B/W 12)	(B/W 13)	(B/W 57)

2
634b

--	--	--	--	--	--

1 N Sethe has at the top of B/W 13

3
634c

T	P	M	N	Nt	Wd
					(B/W 58)

4
634d

--	--	--	--	--	--

5
635a

T	P	M	N	Nt

6
635b

7
635c

T	P	M	N	Nt

8
635d

B/Wg
26

B/W
14

B/W 15

1*
636a-b

T	P	M	N	Nt
(A/W 42)	(B/Wh 1)	(B/Wg 26)	(B/W 14)	(B/W 15)
	 B/Wh 2			

1 TPMN construed as one spell with PT 367

2
636c

T	P	M	N	Nt

3
636d

A/W 43

B/Wg 27

B/W 15

B/W 16

4
637a

T	P	M	N	Nt

5
637b

6
637c

T	P	M	N	Nt

7
638a

B/Wg
28

B/W 17

B/W 16
...
//

8
638b

T	P	M	N	Nt

9
638c

T	P	M	N	Nt

10
638d

T	P	M	N	Nt

11
639a

T	P	M	N	Nt

12
639a-b

13
639b

T	P	M	N	Nt

B/Wg 30

→

→
PT
426

→
PT
370

→
PT
589

→
PT
589

1
640a

T	P	N
(A/W 44)	B/Nw i1	(B/W 60)

2
640b

--	--	--

3
641a

T	P	N

4
641b

--	--	--

5
642a

T	P	N

6
642b

--	--	--

7
642c

--	--	--

8
643a

T	P	N

9
643b

T	P	N

A/W 46

10
643c

T	P	N

11
644a

T	P	N

12
644b

T	P	N

B/W 62

13
644c

T	P	N

14
644d

T	P	N

15
644e

T	P	N

→
PT
535

→
PT
332

T	P	M	N
(A/W 46)	B/Wg 48	(B/Wg 30)	B/Wh i1
<p>1 645a</p>			
<p>2 645b</p>			

T	P	M	N
<p>3 645c</p>			
<p>4 645d</p>			

T	P	M	N
<p>5 646a-b</p>			
<p>6 646c</p>			

7
646d

8
647a

T	P	M	N

AW 48

B/Wg 52

B/Wa 32

B/Wh 12

9
647b-c

T	P	M	N

B/Wg
53

B/Wg 54

10
647d

T	P	M	N

B/Wg 55

PT
425

PT
365

1*
648a

T	P	M	N	Nt
(A/W 48)	(B/Wg 34)	(B/Wg 42)	(B/Wh i 2)	B/W 62

2
648b

B/Wg 43

B/Wg 35

1T erased before

3
648c

T	P	M	N	Nt

5
649a

T	P	M	N	Nt

B/W 63

B/Wh i 3

B/Wg 36

6
649b

7
649c

T	P	M	N	Nt

B/Wg 45

8
649d

9
650a

T	P	M	N	Nt

B/Wg 37

B/W 64

B/Wg 46

A/W 50

10
650b

11
650c

T	P	M	N	Nt

PT
366

1
651a

T	P	M	Nt
(A/W 50)	(B/Wg 37)	B/Wg 47	(B/W 64)

2
651b

3
651c

T	P	M	Nt

4
651d

5
652a

6
652b

T	P	M	Nt

7
653a

8
653b

T	P	M	Nt

9
653c

T	P	M	Nt

B/Wg
50

10 P Original text in B/W 63, erased:



10*
653d

T	P	M	Nt

B/Wg
40

B/Wg 51

→

→
PT
424

→
PT
335

end

1
654a

T	M	N
(A/W 51) 	B/Wh i 4 	(B/W 55)

2
654b

4
654d

T	M	N

5
655a

6
655b

T	M	N

7
655c









3
654c

A/W 52

B/W 57



8
655d

T	M	N
		
		
		









9
656a

A/W 53

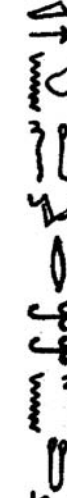
B/Wh i 5







B/W 58

10
656b

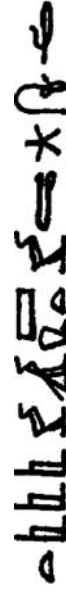
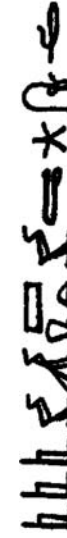
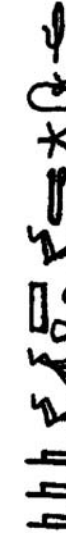
T	M	N
		
		
		

11
656c

12
656d

T	M	N
		
		
		

13
656e

B/W 59

14
657a

T	M	N

15
657b

AW 54

16
657c

T	M	N

17
657d

18
657e

T	M	N
→	PT 442	PT 369

B/W 60

	T	P	Jp
1 658a	(A/W 54)	(B/Se B 43)	(B/E 33)
2 658b			

	T	P	Jp
3 658c			
4 658d	A/W 55		
5 658e			

	T	Jp
6 659a		
7 659b		

	T	P
8 659c		
9 659d		

PT 375

PT 376

1
660a

T	P
A/E 1	(APh/E 48)
	APh/E 49

2
660b

T	P

3
660c

T	P
	APh/E 50



1
661a

T	P
(A/E 1)	(APh/E 50)

2
661b

3
661c

T	P
	(APh/E 51)
A/E 2	



T	P
(A/E 2)	(APh/E 51)
	

1
662a

T	P
	APh/E 52
	

2
662b

3
662c

T	P
	APh/E 53
	
<p>→ PT 281</p>	<p>→ PT *774</p>

4
662d

5
662e

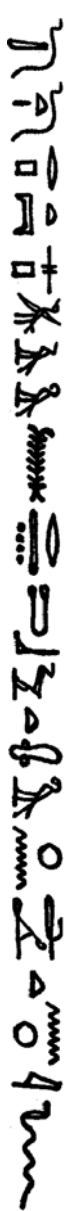
T
(A/E 10)
<p>1 663a</p>  <p>2 663b</p>

T
<p>3 663c</p> 

T
<p>4 664a</p>  <p>5 664b</p>

T
<p>6 664c</p>  <p>7 665a</p> <p style="text-align: center;">A/E 11</p>

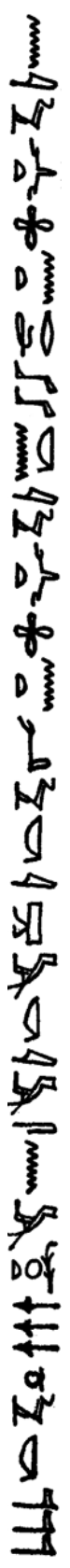
T
<p>8 665b</p>  <p>9 665c</p>

T
<p>10 666a</p> 

T
<p>11 666b</p>  <p style="text-align: center;">PT 299</p>

PT 379

667

T
(A/E 13)

→

PT 380

1 668a
2 668b

T
(A/E 13)

→

PT 381

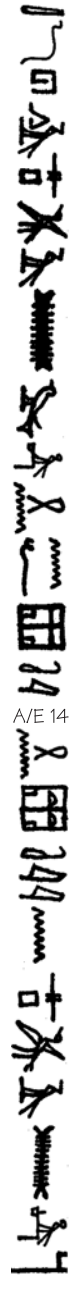
1 669a
2 669b

T
(A/E 13)

A/E 14 → PT 287



PT 382

1 670a
2 670b

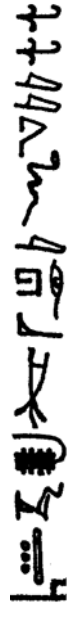



T
(A/E 14)



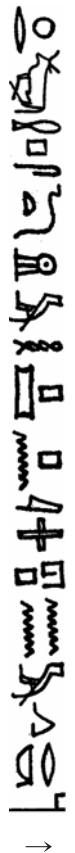

3 670c
→ PT 318

T

→ PT 318

	T
1 671a	(A/E 16) 
2 671b	(A/E 17) 

	T
3 671c	

	T	P
1 672a	(A/E 17) 	(A/E 23) 
2 672b		

	T	P
3 672c		
4 672d		(A/E 24) 
		→ PT 233

	T	
		(A/E 17)
1 673a		
2 673b		
		A/E 18

	T	
		3 673c-d
		

	T	
		5 674b-675a
		
		7 675b

	T	
		8 675c
		
		10 676b
		A/E 19

	T	
		11 676c
		
		13 677b

15
Space for = above
left uncarved

	T	
		14 677c
		

	T	
		16 678a
		
		18 678c
		A/E 20

T
(A/E 20)
<p>1 679a</p> <p>2 679b</p> <p>3 679c</p>

T
<p>4 679d</p> <p>5 679e</p>

T
A/E 21
<p>1 680a</p> <p>2 680b</p>

T
(A/E 21)
<p>1 681a</p> <p>2 681b</p>

T
<p>3 681c</p> <p>4 681d</p>

T
<p>5 681e</p>

T	
(A/E 21)	
1 682a	
2 682b	A/E 22
3 682c	

T	
4 682d	
5* 682e	

5
Space for usual
determinative
(see 386.4-5)
left uncarved

T	
6 682f	

T	(A/E 22)
1 683a	
2 683b	
3 683c	<div style="text-align: center;"> A/E 23 </div>

T	
4 683d	
5 684a	
6*	<div style="text-align: center;"> 684b </div>

T	
7 685a	
8 685b	

6
One group left uncarved

12
In damaged section read probably

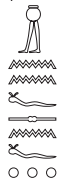

T	
9 685c	 A/E 24

T	
10 685d	
11 686a	

T	
12* 686b	
13 686c	

T
(A/E 24)
1 687a
2 687b
3 687c
A/E 25

T
4 687a
→

T
(A/E 25)
688
→

T
(A/E 25)
1 689a
2 689b

T
A/E 26
3 689c
4 689d
→

T
(A/E 26)
690
→

PT 395

T
(A/E 26)
1 691a
2 691b
→

PT 396

T
(A/E 26)
692a
→

PT 397

T
(A/E 26)
1 692b
A/E 27
2 692c
→

PT 398

T
(A/E 27)
1 693a
2 693b
→

T
3 693c
4 693d
→

PT 399

T
(A/E 27)
694
→ PT 273-74

T	M	N
(A/E 40)	(B/E 51 +fr. Or L)	(B/Eg 38)
<p>1 695a</p>		
<p>2 695b</p>		
<p>3 695c</p>		

T	M	N
<p>4 695c- 696b</p>		

T	N
<p>6 696d</p>	
<p>7 696e</p>	

T	M	N

	T	P	M	N
	(A/E 41)	(AP ₃ /E 16)	(B/E 54 +fr. Or L)	(B/E 56)
1* 697a				
2 697b				

	T	P	M	N
3 697c				
4 697d				

1 P As one spell with PT 353 preceding

	T	P	M	N
5 697e				

	T	P	M	N
1 69b _a	(A/E 42) 	(APs/E 18) 	(B/E 55 +fr. Or L) 	(B/E 57)
2 69b _b		APs/E 19 		

	T	P	M	N
3 69b _c				
4 69b _d				

APs/E 20

1
699a

T	P	M	N
(A/E 42)	(APs/E 20)	B/E 59 +fr. Or L	(B/E 57)
	APs/E 21		

2
699b

3
699c

T	P	M	N
	APs/E 22		

4
700a

... (rest lost)

5
700b

T	M	N

6
700c

...
B/E 60

A/E 43

B/E 58

T	M	N

7
701a

8
701b

B/E 59

T	M	N





9
701c

↑
P1
206



↑
P2
603

↑
P3
662

1
702a

T	P	Sethe	M	N
(A/E 45)	(AP ₃ /E 6)		(B/E 60)	(B/Eg 56)
	 <p>AP₃/E 7</p>		 <p>B/E 61</p>	 <p>B/Eg 57</p>

2
702b

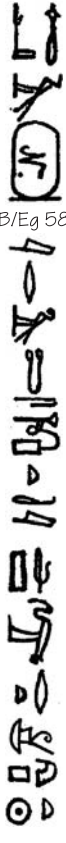
T	P	Sethe	M	N
		 <p>...</p>		 <p>B/Eg 58</p>

	T	P	Sethe	M	N
					B/Eg 59
3 702c		 AP ₆ /E 8	 	 ...	 B/Eg 60
4 702d		 ...	→	 ...	 B/Eg 61
		→ PT 350	→	→ PT [661]	→

T	P	N
(A/E 45) 173 703a	(AP3/E 11) 	(B/Eg 61) 174 703a
 A/E 46	 AP3/E 12	B/Eg 62 175 703a end
2 703b 		(B/E 55)

T	P	N
3 704a 		 AP3/E 13
4 704b 		

T	P	N
5 704c 		 AP3/E 14
6 704d 		

7
705a

T	P	N

8
705b

T	P	N

A/E 47

AP/E 15

B/E 56

9
705c

T	P	N

PT 353







PT 353

	T	M	Na	Nb
1 706a	(A/E 47)	(A/E 13 fr. Or M+N)	(B/Eg 41)	(A/E 28)
		 (lost to 6)		
2 706b			B/Eg 42 	
3 707a			A/E 29 	

	T	Na	Nb
4 707b			
5 707c		B/Eg 43 	A/E 48

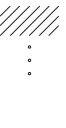





	T	M	Na	Nb
6 707d				
7 708a				

8
708b

T	M	Na	Nb
			A/E 30 //... 
	... (lost to 12)	B/Eg 44 	
			... 



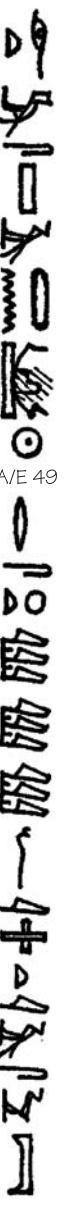
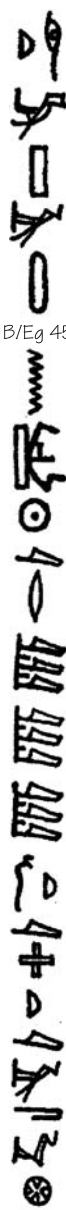

9
708c

10
709a

T	Na	Nb
		
		
	B/Eg 45 	A/E 49 

11
709b-c

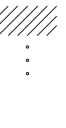
12
709d

T	M	Na	Nb
			A/E 31 //... 
	→ PT *714	→ PT 347	→ PT *778

1
710a

T	pa	pb	An	M	N
(A/E 49)	B/E 11	(A/W 44)	(B/E i 23)	(B/Eg 36)	(B/E 8)

5
711c-d

T	pa	pb	An	M	N
B/E i 25					
B/Ea 38					

6
712a

T	pa	pb	An	M	N
B/Eg 39					
B/E 12					
B/E i 26					

7
712b

8
712c

T	pa	pb	An	M	N

A/E 51

B/E 10

B/Eg 40

9
713a

10
713b

T	pa	pb	An	M	N

1
714a

T	pa	pb'	pb
(A/E 51)	(A/E 4)		A/E 17

2
714b

3
715a

T	pa'	pa	pb'	pb
		A/E 5		

4
715a

5
715b

6*
715c

T	pa'	pa	pb'	pb

6-7 pa

7*
716a-b

T	pa'	pa	pb

8
716c

(1901 1902) ...
↓ PT 491A

9
716d





T	pb

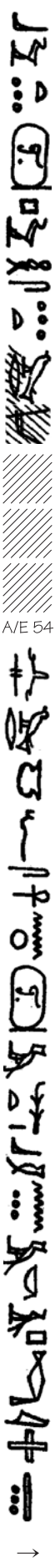

10
716e

↓ PT 497

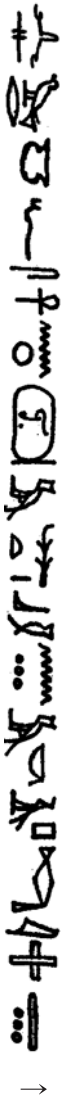
T
(A/E 53)
1 717a 
2 717b 

T
3 717c-d 





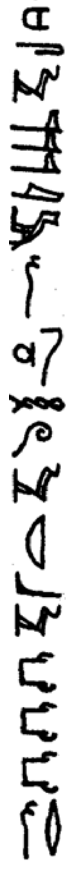

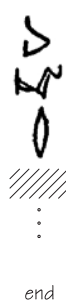



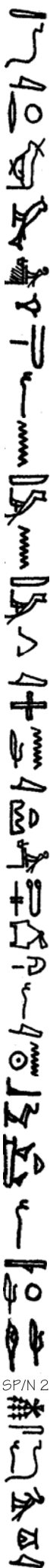







T
4 718a 
5 718a-b 
A/E 54 
6 718c 
↑

T
(A/E 54)
1 719a 
2 719b 

T
3 719c 
4 719d 

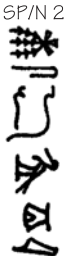
T
6 719e 
end

1
721a-b





















T	P	N	Nt ^a	Nt ^b
SP/N 1	B/Sw A 27	(B/Nw ii 35)	(B/Sw 19)	(B/Se ii 59)
		 B/Nw ii 36	 B/Sw 20	
				
				
				

2
721c

3
721c

SP/N 2

4
722a-b









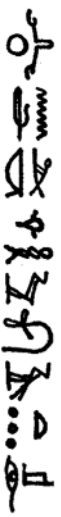

T	P	N	Nt ^a	Nt ^b
	(B/Sw A 28)			
				 B/Se ii 60
				
				
				

SP/N 3

B/Sw 21







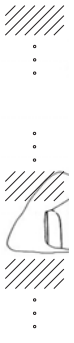

B/Nw
ii 37

6
722d

T	P	N	Nt ^a	Nt ^b
				
				

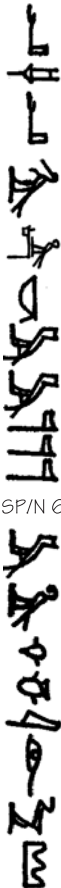
7
723a

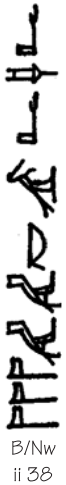
8
723b

T	P	N	Nt ^a	Nt ^b
				
				

9
723c

(11.01.1991)

(11.01.1991)

B/Se ii 61

B/Se ii 62

B/Nw ii 38

SP/N 6

SP/N 4

SP/N 5

B/Sw A 29

B/Sw 22

10
724a-b

T	Nt ^a	Nt ^b

11
724b-c

T	P	N	Nt ^a	Nt ^b

12
724d

13
725a

T	N	Nt ^a	Nt ^b

14
725b

15
725c

B/Nw
ii 39

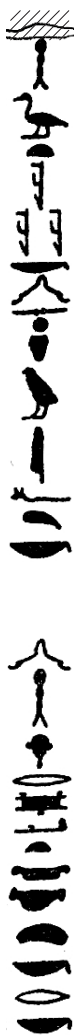

B/Sw 24



B/Se
ii 64



B/Sw 23



B/Se
ii 63







B/Sw A
30



(lost for 10)

16
725d



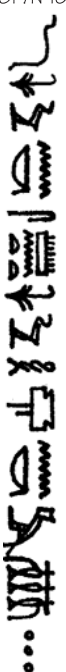

T	P	N	Nt ^a	Nt ^b
	(B/Sw A 31) 			

16
726a

SP/N 10



18
726b

T	P	N	Nt ^a	Nt ^b
				

SP/N 11



19
727a

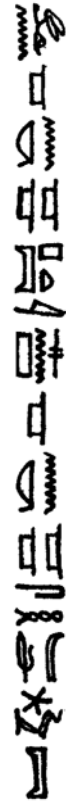

B/Nw
ii 40

B/Se
ii 65

B/Sw 25

20
727b









T	P	N	Nt ^a	Nt ^b







21
727c

22
728a





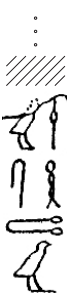



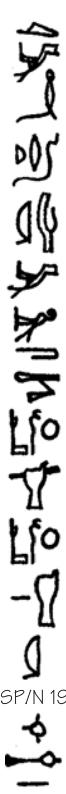

T	P	N	Nt ^a	Nt ^b

23
728b

T	N	Nt ^a	Nt ^b
<p>24 728c</p>  <p>SP/N 14</p>		<p>...</p>  <p>B/5e ii 67</p>	
<p>25 729a</p> 			



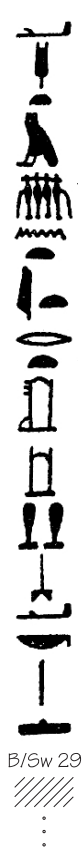



T	N	Nt ^a	Nt ^b
<p>26 729a-b</p>  <p>SP/N 15</p>	 <p>B/Nw ii 42</p> <p>...</p>	 <p>B/5w 27</p> <p>...</p>	
<p>27 729c</p> 	<p>...</p> 		

32
731b

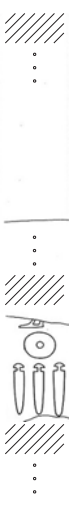
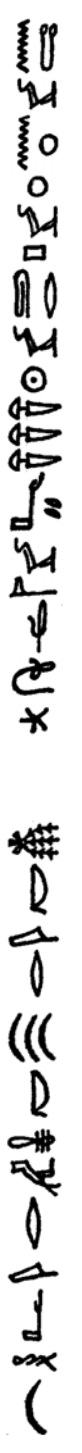
T	P	N	Nt ^a	Nt ^b
 <p>5P/N 19</p>				 <p>B/6e ii 70</p>
	 <p>end</p>		 <p>B/5w 29</p>	

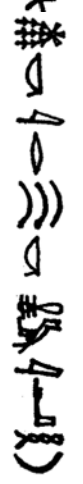
33
731c

34
732a

T	P	N	Nt ^a	Nt ^b
 <p>5P/N 20</p>	<p>B/5w A 36</p> 	<p>B/W 1</p> 		
				

35
732b

36
732c

T	P	N	Nt ^a	Nt ^b
(B/Sw A 37)				
5P/N 21				
B/6e ii 71				
B/Sw 30				
... (rest last) ...				
PT 665B				
5P/N 22				

37
733a

38
733b

39
733c

T	P	N	Nt ^b
... ...			
→	→ PT 625A	→ PT 449	→ CT *714

40
733d

1 734a		T
	SF/N 23	
2 734b		

3 734c		T
	SF/N 24	
4 734d		
5 735a		
	SF/N 25	

6 735b		T
7 735c		
	SF/N 26	

8 736a		T
9 736b		
	SF/N 27	

8
Space for
after second 
left uncarved

10 736c		T
		end

1
738a-b

T	P
(SP/5 3)	SP/5 6
SP/5 4	
	SP/5 7
	SP/5 5

2
738b

3
738c

4
739a

5
739b

T	P
	SP/5 8
	SP/5 6
	SP/5 9

6
739c

T	P
	SP/5 7
→	→
	PT *748

740

T	P
(SP/5 7)	SP/5 1
→	→
	PT *747

	T
1 741a	SP/S 8
2 741b	
3 741c	SP/S 9

	T
4 741d	
5 741e	SP/S 10
	→

	T	M	Na	Nb
1 742a	(SP/S 10) 	(A/Eg 33) 	B/E 63 	(A/E 7)
2 742b				
	SP/S 11	A/Eg 34		

	T	M	Na	Nb
3 742c				(A/E 8)
	→	→ PT 605	→ PT 201	→ PT 466

1
743a

T	M
(SP/S 12)	(A/Eg 25)

2
743b

SP/S 13

3
743c

T	M

4
743d

SP/S 14

A/Eg 26

5
744a

T	M

6
744b

SP/S 15

A/Eg 27

7
745a

T	M

8
745b

SP/S 16

A/Eg 28

9
745c-d

T	M

10
746a

SP/S 18

SP/S 17

11
746b

T	M	N
	A/Eg 29	(A/S C 1)

12
746c

SP/5 19



13
747a

T	M	N
	A/Eg 30	(lost 19)

14
747b

SP/5 20

A/Eg 30

15
748a

T	M
	SP/5 21
	A/Eg 31

16
748b

SP/5 21

A/Eg 31

17
748c

T	M	N
		(A/S C 2)
	SP/5 22	
	SP/5 23	

18
748d

19
749a

SP/5 23

20
749b

T	M	N

21
749c

T	M

22
749d-e

T	M

→
PT
421

